

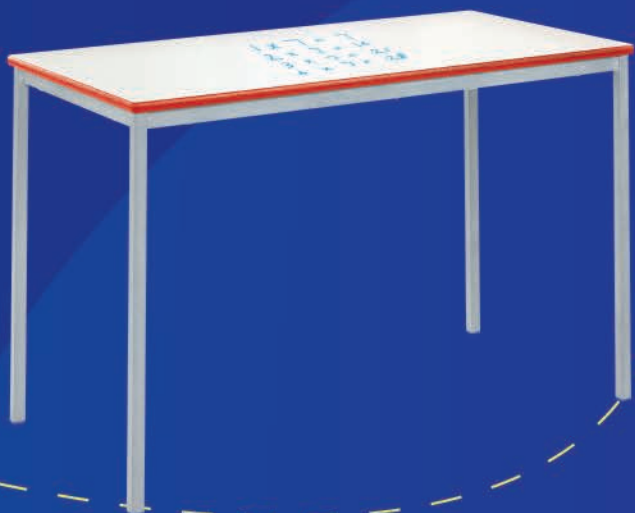

WINSCOMBE
FURNITURE



Secondary

Furniture Range





Inspirational Educational Furniture

If you are looking for an exceptional furniture specialist that can provide you with fantastic products alongside the highest level of customer service, then please contact us for more information.

-  01623 427 596
-  sales@winscombefurniture.com
-  <https://winscombefurniture.com>



- 4** How to Order
- 5** Standing and Working Heights



Chairs

- 7** BS Chairs
- 8** BS Chair: Colour Collection
- 9** Chair 2000: Four Legged & Skid Base
- 10** NP Chairs
- 11** NP Chair: Colour Collection
- 12** NP Chair: Black & White
- 13** ST Chairs
- 14-15** Beam Seating
- 16** Upholstered Chairs



Stools

- 18** 25 Series Stool
- 19** 35 Series Stool
- 20** High Chairs: BS, Chair 2000 & NP
- 21** WSM Stool: Four Legged
- 22** WSM Stool: Skid Base



Tables

- 24-25** Craft Tables: Crushed Bent H Frame, Fully Welded H Frame
- 26** Craft Tables: Premium H Frame
- 27** Crushed Bent Tables
- 28** Crushed Bent Table: Colour Collection
- 29** Elite Tables: Static & Height Adjustable
- 30-31** Equation™ Tables
- 32** Equation™ Table: Leaf
- 33** Equation™ Table: Jewel
- 34** Euro Tables: Single, Double & Large Double
- 35** Exam Desks
- 36-37** Fully Welded Tables

- 38** Fully Welded Tables: BURO Edge
- 39** Fully Welded Tables: Colour Collection
- 40** Height Adjustable Table: HA200
- 41** Height Adjustable Table: HA600
- 42** Meeting Room Tables
- 43** Premium Tilt Top Tables
- 44-45** RT32 Tables
- 46** RT32 Tables: White Tables
- 47** RT45 Tables
- 48** Shaped Table: Connect
- 49** Shaped Table: Segga
- 50** Teachers Desk: Crushed Bent & Fully Welded
- 50** Teachers Desk: RT45 Premium
- 52** White Board Top Tables



Dining

- 54** Four Seater Bench
- 55** Four Seater Canteen Table & NP Chairs
- 56** Four Seater Cantilever Table & NP Chairs
- 57** Standard Dining Tables & Benches
- 58** Tilt Top Dining Tables
- 59** Two Seater Canteen Table & NP Chair



Extras

- 61** Storage Tray Racks
- 62** Wooden Tray Units
- 63** Trays



Swatches

- 65-67** Swatches

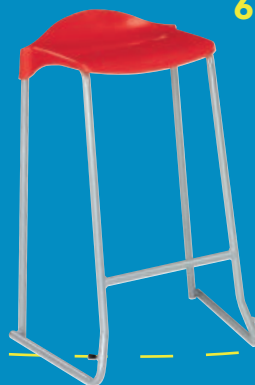



How to Order

To ensure you choose all the required options when placing an order, we have shown below examples of the typical options you may need to select.

Chairs

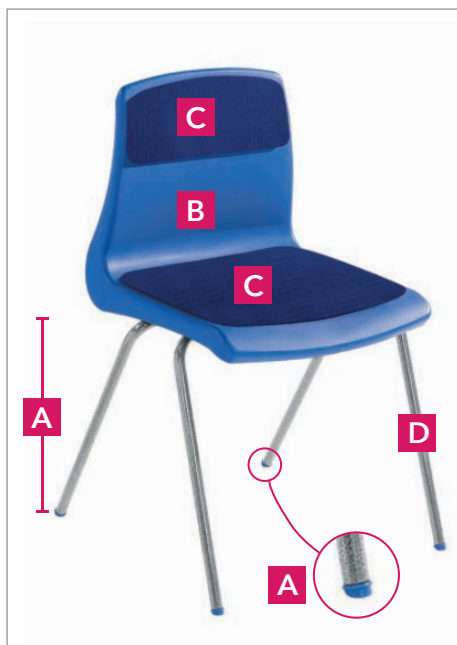

Tables

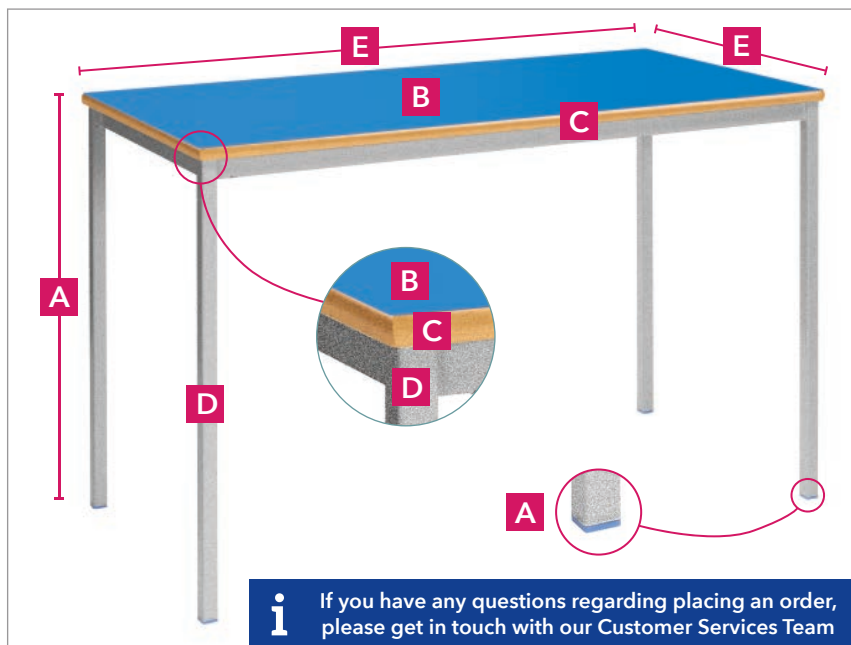

If you have any questions regarding placing an order, please get in touch with our Customer Services Team

Chair ordering example

A Seat height | B Shell colour | C Fabric colour (optional extra) | D Frame colour

Table ordering example

A Table height | B Laminate colour | C Edge style (+ colour if applicable) | D Frame colour | E Table top size



Standing and Working Heights

To help you purchase furniture that complies with the British and European Standards (1729), the following height guide indicates which fixed seat heights and table heights are suitable for the correct age and size. To ensure you purchase the most accurate height furniture in compliance with the standards, we recommend that you measure the stature and popliteal height. You can then match those measurements using the guide below.

Size Mark

1. Nursery (3-4 years)

250-280mm Popliteal Height Range
 930-1150mm Stature Range
 590mm Standing Table Height
 460mm Table Height
 260mm Chair Height

2. Primary (4-6 years)

280-315mm Popliteal Height Range
 1080-1210mm Stature Range
 710mm Standing Table Height
 530mm Table Height
 310mm Chair Height

3. Primary (6-8 years)

315-355mm Popliteal Height Range
 1190-1420mm Stature Range
 760mm Standing Table Height
 590mm Table Height
 350mm Chair Height

4. Primary (8-11 years)

355-405mm Popliteal Height Range
 1330-1590mm Stature Range
 900mm Standing Table Height
 640mm Table Height
 380mm Chair Height

5. Secondary (11-14 years)

405-435mm Popliteal Height Range
 1460-1765mm Stature Range
 1000mm Standing Table Height
 710mm Table Height
 430mm Chair Height

6. Secondary / Adult (14+ years)

435-485mm Popliteal Height Range
 1590-1880mm Stature Range
 1000mm Standing Table Height
 760mm Table Height
 460mm Chair Height

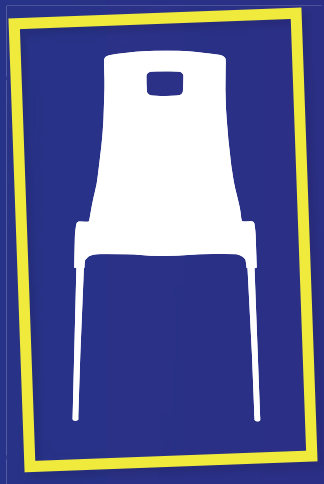

Chairs



BS Chairs

- ✓ Unbeatable and durable frame design.
- ✓ Two piece plastic construction provides excellent lumbar support.
- ✓ Stackable to 5 high.
- ✓ BSEN 1729 compliant.
- ✓ 5 year guarantee.



1 Choose Your Chair

CODE	AGE RANGE	SEAT HEIGHT (SH)
BSE	11-14 years	430mm
BSF	14 +	460mm

2 Choose Your Shell Colour



3 Choose Your Frame Colour



Images shown are for illustrative purposes only.
*Silver & White frames are non-returnable.





BS Chairs: Colour Collection

- ✓ Choose your shell and frame colour from a vibrant choice of 10 different colours*.
- ✓ Two piece plastic construction provides excellent lumbar support.
- ✓ Stackable to 5 high.
- ✓ BSEN 1729 compliant.
- ✓ 5 year guarantee.



1 Choose Your Chair

CODE	AGE RANGE	SEAT HEIGHT (SH)
BSE	11-14 years	430mm
BSF	14 +	460mm

Please note: matching seat colours and frame colours are similar in shade but not identical. Swatches can be provided for both upon request. ***Orders are non-returnable.**

2 Choose Your Shell Colour



3 Choose Your Frame Colour





Chair 2000: Four Legged & Skid

- ✓ Choose between two chair frame styles.
- ✓ Extremely strong and durable.
- ✓ Unrivalled posture support across all ages.
- ✓ Chair 2000 Four Legged stackable to 7 high, Chair 2000 Skid stackable to 6 high.
- ✓ 5 year guarantee.

Chair 2000 Four Legged



Chair 2000 Skid Base



1 Choose Your Four Legged Chair

CODE	AGE RANGE	SEAT HEIGHT (SH)
2020	11-14 years	430mm
2021	14 +	460mm

1 Choose Your Skid Base Chair

CODE	AGE RANGE	SEAT HEIGHT (SH)
2040	11-14 years	430mm
2041	14 +	460mm

2 Choose Your Shell Colour



3 Choose Your Frame Colour



Images shown are for illustrative purposes only.
*Silver & White frames are non-returnable.



NP Chairs

- ✓ The traditional classroom chair.
- ✓ A robust general purpose chair.
- ✓ Well defined lumbar support.
- ✓ Stackable to 8 high.
- ✓ BSEN 1729 compliant.
- ✓ 5 year guarantee.



1 Choose Your Chair

CODE	AGE RANGE	SEAT HEIGHT (SH)
NP5	11-14 years	430mm
NP6	14 +	460mm

2 Choose Your Shell Colour



3 Choose Your Frame Colour



Images shown are for illustrative purposes only.
*Silver & White frames are non-returnable.



NP Chairs: Colour Collection

- ✓ Choose your shell and frame colour from a vibrant choice of colours.
- ✓ The traditional classroom chair.
- ✓ Well defined lumbar support.
- ✓ Stackable to 8 high.
- ✓ BSEN 1729 compliant.
- ✓ 5 year guarantee.



1 Choose Your Chair

CODE	AGE RANGE	SEAT HEIGHT (SH)
NP5	11-14 years	430mm
NP6	14 +	460mm

Please note: matching seat colours and frame colours are similar in shade but not identical. Swatches can be provided for both upon request. ***Orders are non-returnable.**

2 Choose Your Shell Colour

BL Blue	CH Charcoal	GN Green	LI Lilac	OR Orange	PU Purple	RD Red	SB Soft Blue	TG Tangy Green	YE Yellow
----------------	--------------------	-----------------	-----------------	------------------	------------------	---------------	---------------------	-----------------------	------------------

3 Choose Your Frame Colour

BL Blue	MC Metallic Charcoal	GN Green	PV Pastel Violet	PO Pastel Orange	PU Purple	RD Red	SB Soft Blue	TG Tangy Green	YE Yellow
----------------	-----------------------------	-----------------	-------------------------	-------------------------	------------------	---------------	---------------------	-----------------------	------------------

NP Chairs: Black & White

- ✓ Choose to have matching shells and frames or 'mix n match'.
- ✓ The traditional classroom chair
- ✓ Well defined lumbar support.
- ✓ Stackable to 8 high.
- ✓ BSEN 1729 compliant.
- ✓ 5 year guarantee.



1 Choose Your Chair

CODE	AGE RANGE	SEAT HEIGHT (SH)
NP5	11-14 years	430mm
NP6	14 +	460mm

2 Choose Your Shell Colour



3 Choose Your Frame Colour

DP1	BK	MC	LG	SV	WH
Duraform Speckled Light Grey	Black	Metallic Charcoal	Light Grey	Silver	White

4 Choose Your Upholstery Colour (Optional Extra)

Havana	Adobo
--------	-------

Please note: matching seat colours and frame colours are similar in shade but not identical. Swatches can be provided for both upon request. **All orders are non-returnable.**



ST Chairs

- ✓ Anti-tilt design.
- ✓ Comfortable and supportive design for correct posture.
- ✓ No nuts or screws.
- ✓ Stackable to 10 high.
- ✓ BSEN 1729 compliant.
- ✓ Amazing 15 year guarantee.



1 Choose Your Chair

CODE	AGE RANGE	SEAT HEIGHT (SH)
ST5	11-14 years	430mm
ST6	14 +	460mm

2 Choose Your Shell Colour



3 Choose Your Frame Colour



DP1
Duraform Speckled
Light Grey

4 Choose Your Accessory



Linking Device
LD



Chair Trolley
CHAIRTR



Beam Seating

- ✓ Available in four different beam seating options for ultimate flexibility.
- ✓ Perfect for communal areas, breakout zones and waiting areas.
- ✓ 60 x 40mm box frame.
- ✓ Solid 25mm MDF tops with a high pressure laminate.
- ✓ Supplied with height adjustable feet.
- ✓ 2 year guarantee.

Two Seater NP Chairs & Table



Three Seater NP Chairs

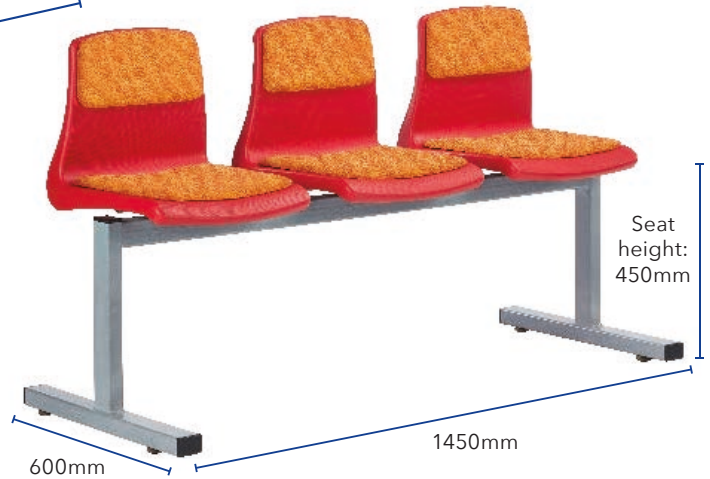

Three Seater NP Chairs & Table

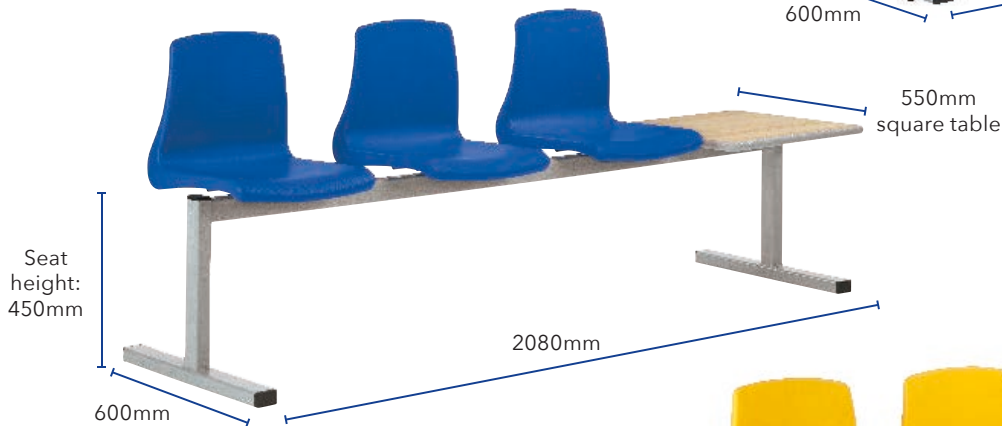

Four Seater NP Chairs



Orders are non-returnable.

Beam Seating

- ✓ Available in four different beam seating options for ultimate flexibility.
- ✓ Perfect for communal areas, breakout zones and waiting areas.
- ✓ 60 x 40mm box frame.
- ✓ Solid 25mm MDF tops with a high pressure laminate.
- ✓ Supplied with height adjustable feet.
- ✓ 2 year guarantee.



1 Choose Your Beam Seating

SEATING	TABLE DIMENSIONS (L X W)	OVERALL DIMENSIONS (L X W)	CODE
Two Seater NP Chairs & Table	550 x 500mm	1695 x 600mm	BBTBL-2SEATER
Three Seater NP Chairs	-	1450 x 600mm	BB-3SEATER
Three Seater NP Chairs & Table	550 x 500mm	2080 x 600mm	BBTBL-3SEATER
Four Seater NP Chairs	-	1950 x 600mm	BB-4SEATER

2 Choose Your Shell Colour

BL Blue	CH Charcoal	GN Green	LI Lilac	OR Orange	PU Purple	RD Red	SB Soft Blue	TG Tangy Green	YE Yellow	BK Black	WH White
----------------	--------------------	-----------------	-----------------	------------------	------------------	---------------	---------------------	-----------------------	------------------	-----------------	-----------------

3 Choose Your Upholstery Colour (Optional Extra)

Scuba	Osumi	Taboo	Bridge-town	Tortuga	Tarot	Panama	Parasol	Madura	Solano	Havana	Adobo
-------	-------	-------	-------------	---------	-------	--------	---------	--------	--------	--------	-------

4 Choose Your Frame Colour

DP1	BK	MC	LG	WH	SV
Duraform Speckled Light Grey	Black	Metallic Charcoal	Light Grey	White*	Silver*

5 Choose Your Laminate Top Colour (Tables Only)**

BH Beech	MA Maple	OK Oak	WH White
-----------------	-----------------	---------------	-----------------

6 Choose Your Edge Style (Tables Only)

PSCH	PSBL	PSGN	PSRD	PSGY	MD
Duraform PU Charcoal	Duraform PU Blue	Duraform PU Green	Duraform PU Red	Duraform PU Light Grey	Standard MDF Bullnose

*Silver & White frames are non-returnable.

**Other laminate top colours are available on request.

Orders are non-returnable.



Upholstered Chairs

- ✓ Available on four chair styles.
- ✓ Choose from a vibrant choice of upholstered options.
- ✓ Only available on chair sizes 5 & 6.

Chair 2000 Four Legged



Chair 2000 Skid Base



NP Chair



ST Chair*



2 Choose Your Upholstery Colour

-  Scuba
-  Osumi
-  Taboo
-  Bridgetown
-  Tortuga
-  Tarot
-  Panama
-  Parasol
-  Madura
-  Solano

1 Choose Your Seat Pad

PAD	CODE
Seat	SP
Seat & Back	SBP

Please note: seat pads match seat shell colours. Swatches can be provided for both upon request. *Only available with seat pad.



Stools



25 Series Stool

- ✓ Traditional looking Laboratory/Craft stools.
- ✓ Supplied with hand hole as standard.
- ✓ Supplied with a polished and lacquered MDF top.
- ✓ Stackable to 6 high.
- ✓ Compliant to EN1729 Part 2.
- ✓ 5 year guarantee.



1 Choose Your Stool

CODE	SEAT HEIGHT (SH)
25RT1	470mm
25RT2	520mm
25RT3	570mm
25RT4	620mm
25RT5	670mm

2 Choose Your Seat Colour



MDF MDF Polished

3 Choose Your Frame Colour

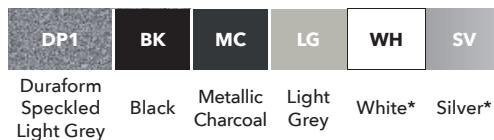

Duraform
Speckled
Light Grey

Black

Metallic
Charcoal

Light
Grey

White*

Silver*

Images shown are for illustrative purposes only.
*Silver & White frames are non-returnable.

4 Choose Your Edge Style



MDF Polished and lacquered

5 Choose Your Accessory



STEEL FEET - Essential where highly abrasive non-slip flooring is used.
WSM-METAL-FOOT





35 Series Stool

- ✓ Sleek and stylish Beech MDF Ply wood top stool with a waterfall front edge.
- ✓ Ideal for Laboratory and Craft environments.
- ✓ Stacks to 8 high.
- ✓ Supplied with a hand hole as standard.
- ✓ 5 year guarantee.



1 Choose Your Stool

CODE	SEAT HEIGHT (SH)
35RT4	640mm
35RT5	670mm

2 Choose Your Seat Colour*

BHP Beech Ply

3 Choose Your Frame Colour

DP1	BK	MC	LG	WH	SV
Duraform Speckled Light Grey	Black	Metallic Charcoal	Light Grey	White **	Silver **

*Coloured tops are available on request (POA).
MOQ of 60 stools applies to coloured tops only.
Supplied Beech Ply as standard.
**Silver & White frames are non-returnable.

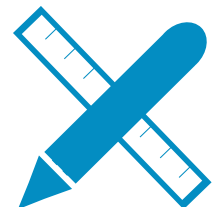



High Chairs: BS, Chair 2000 & NP

- ✓ High chairs available in 3 best selling chair styles.
- ✓ Perfect for use in ICT, Craft and Science environments.
- ✓ High chairs represents an impressive combination of durability and comfort.
- ✓ Each stool is available in 2 sizes and a variety of colour options.
- ✓ 5 year guarantee.

BS High Chair



1 BS High Chair

CODE	SEAT HEIGHT (SH)
MS127	640mm
MS128	670mm

Chair 2000 High Chair



Chair 2000 High Chair

CODE	SEAT HEIGHT (SH)
2104	620mm
2105	670mm

NP High Chair



NP High Chair

CODE	SEAT HEIGHT (SH)
NP5ST4	610mm
NP5ST5	670mm

2 Choose Your Shell Colour



3 Choose Your Upholstery Colour (Optional Extra)



4 Choose Your Frame Colour

DP1	BK	MC	LG	WH	SV
Duraform Speckled Light Grey	Black	Metallic Charcoal	Light Grey	White*	Silver*

5 Choose Your Accessory



STEEL FEET - Essential where highly abrasive non-slip flooring is used.
WSM-METAL-FOOT

*Silver & White frames are non-returnable.
**Available on Chair 2000 High Chair only.



WSM Stool: Four Legged

- ✓ Classic stacking stool.
- ✓ Excellent lumbar support.
- ✓ Comfortable and stylish.
- ✓ Stackable to 6 high.
- ✓ BSEN 1729 compliant.
- ✓ 5 year guarantee.



1 Choose Your Stool

CODE	SEAT HEIGHT (SH)
WSM2	445mm
WSM3	560mm
WSM4	610mm
WSM5	685mm

Images shown are for illustrative purposes only.
*Silver & White frames are non-returnable.



2 Choose Your Shell Colour



3 Choose Your Frame Colour

DP1	BK	MC	LG	WH	SV
Duraform Speckled Light Grey	Black	Metallic Charcoal	Light Grey	White*	Silver*

4 Choose Your Accessory



STEEL FEET - Essential where highly abrasive non-slip flooring is used.
WSM-METAL-FOOT

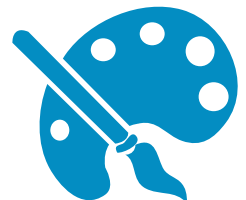



WSM Stool: Skid Base

- ✓ Non tilt frame protects floor in high wear situations.
- ✓ Robust anti-tilt design.
- ✓ Integral lumbar support.
- ✓ Stackable to 6 high.
- ✓ BSEN 1729 compliant.
- ✓ 5 year guarantee.

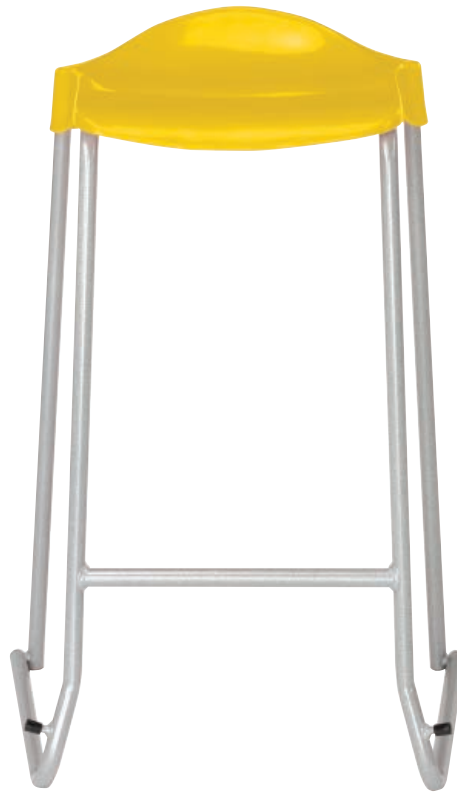

1 Choose Your Stool

CODE	SEAT HEIGHT (SH)
WSM2SKID	445mm
WSM3SKID	560mm
WSM4SKID	610mm
WSM5SKID	685mm

Images shown are for illustrative purposes only.
*Silver & White frames are non-returnable.

Glides example



2 Choose Your Shell Colour



3 Choose Your Frame Colour

DP1	BK	MC	LG	WH	SV
Duraform Speckled Light Grey	Black	Metallic Charcoal	Light Grey	White*	Silver*

4 Choose Your Accessory



STEEL FEET - Essential where highly abrasive non-slip flooring is used.
WSM-METAL-FOOT



GLIDES - Essential where highly abrasive non-slip flooring is used. 6 x glides provided per skid frame stool. Factory fitted - must be purchased at the same time of ordering the stool.
WSMSKID-GL

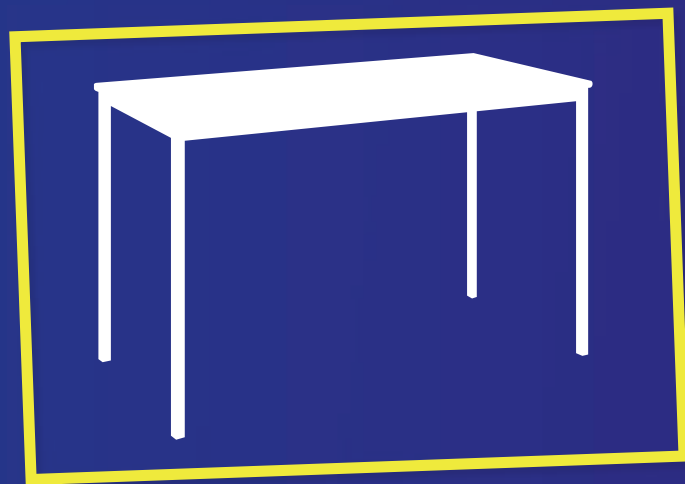

Tables

Craft Tables: Crushed Bent H Frame, Fully Welded H Frame

- ✓ Sturdy and practical H frame tables.
- ✓ Perfect for Art, Food Technology, Science and Craft environments.
- ✓ Versatile range for use throughout the school.
- ✓ Available in three different edge finishes.
- ✓ BSEN 1729 compliant.
- ✓ 5 year guarantee.



Crushed Bent H Frame

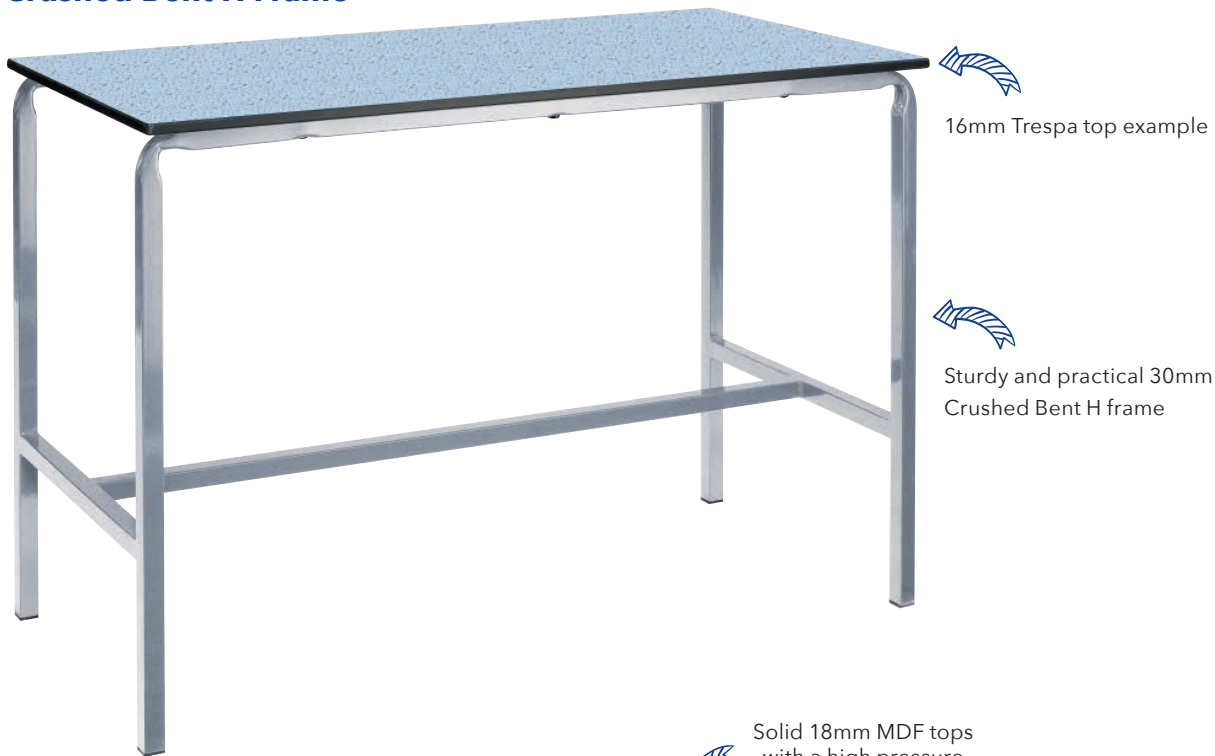

Solid 18mm MDF tops with a high pressure laminate

Fully Welded H Frame

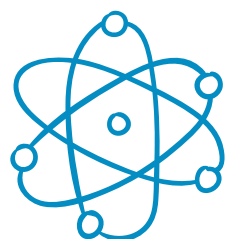



Craft Tables: Crushed Bent H Frame, Fully Welded H Frame

- ✓ Sturdy and practical H frame tables.
- ✓ Perfect for Art, Food Technology, Science and Craft environments.
- ✓ Versatile range for use throughout the school.
- ✓ Available in three different edge finishes.
- ✓ BSEN 1729 compliant.
- ✓ 5 year guarantee.

1 Choose Your Table Shape

TABLE STYLE	SIZE (L X W)	MDF EDGE CODE	DURAFORM EDGE CODE	TRESPA CODE
Crushed Bent H Frame	1200 x 600mm	CBCRAFT-126-MD	CBCRAFT-126-PS	CBCRAFT-126-TRES
Crushed Bent H Frame	1200 x 750mm	CBCRAFT-127-MD	CBCRAFT-127-PS	CBCRAFT-127-TRES
Crushed Bent H Frame	1500 x 750mm	CBCRAFT-157-MD	CBCRAFT-157-PS	CBCRAFT-157-TRES
Fully Welded H Frame	1200 x 600mm	CRAFT-126-MD	CRAFT-126-PS	CRAFT-126-TRES
Fully Welded H Frame	1200 x 750mm	CRAFT-127-MD	CRAFT-127-PS	CRAFT-127-TRES
Fully Welded H Frame	1500 x 750mm	CRAFT-157-MD	CRAFT-157-PS	CRAFT-157-TRES

2 Choose Your Table Height

HEIGHT
760mm
800mm
850mm
900mm
950mm
1000mm

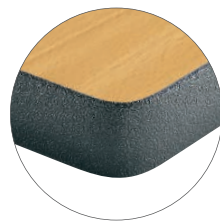

Duraform PU edge example

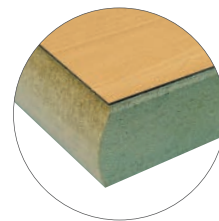

Polished and lacquered MDF Bullnose edge example

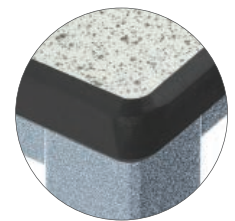

16mm Trespa top example

3 Choose Your Laminate Top Colour



Trespa Top Colours



4 Choose Your Frame Colour



Images shown are for illustrative purposes only.
*Silver & White frames are non-returnable.

5 Choose Your Edge Style



Craft Tables: Premium H Frame

- ✓ Perfect for Art, Food Technology, Science and Craft environments.
- ✓ Sturdy and practical chunky 45mm round tube H frame.
- ✓ Solid 18mm MDF tops with a high pressure laminate tops.
- ✓ 10 year guarantee.

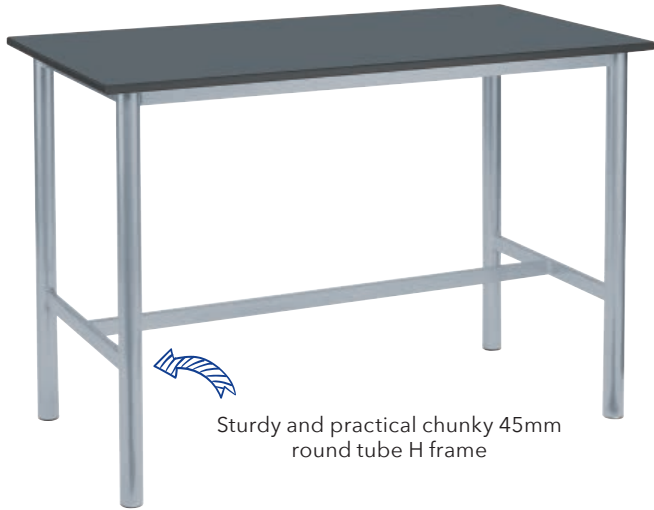

1 Choose Your Table

SIZE (L X W)	MDF EDGE CODE	DURAFORM EDGE CODE	TRESPA CODE
1200 x 600mm	PRCRAFT-126-MD	PRCRAFT-126-PS	PRCRAFT-126-TRES
1200 x 750mm	PRCRAFT-127-MD	PRCRAFT-127-PS	PRCRAFT-127-TRES
1500 x 750mm	PRCRAFT-157-MD	PRCRAFT-157-PS	PRCRAFT-157-TRES

2 Choose Your Table Height

HEIGHT
760mm
800mm
850mm
900mm
950mm
1000mm

3 Choose Your Laminate Top Colour



Trespa Top Colours



4 Choose Your Frame Colour



Images shown are for illustrative purposes only.
*Silver & White frames are non-returnable.

5 Choose Your Edge Style





Crushed Bent Tables

- ✓ Supplied with a hard wearing 18mm MDF top and a sturdy Crushed Bent 25mm square tube frame.
- ✓ Available in five different shapes for ultimate classroom flexibility.
- ✓ Stackable to 8 high for ease of storage.
- ✓ BSEN 1729 compliant.
- ✓ 5 year guarantee.

Rectangular



Square



Trapezoidal



Circular*



Semi-Circular



*Not stackable.

**Silver & White frames are non-returnable.

1 Choose Your Table

SHAPE	SIZE (L X W)	MDF EDGE CODE	DURAFORM EDGE CODE
Rectangular	1200 x 600mm	CBSQ-126-MD	CBSQ-126-PS
Square	600 x 600mm	CBSQ-66-MD	CBSQ-66-PS
Trapezoidal	1200 x 600mm	CBSQ-12LE-MD	CBSQ-12LE-PS
Circular	750mm Diameter	CBSQ-7C-MD	CBSQ-7C-PS
Circular	1000mm Diameter	CBSQ-10C-MD	CBSQ-10C-PS
Semi-Circular	1200mm Diameter	CBSQ-12SC-MD	CBSQ-12SC-PS

2 Choose Your Table Height

HEIGHT	AGE RANGE
710mm	11-14 Years
760mm	14+ Years

3 Choose Your Laminate Top Colour



4 Choose Your Frame Colour

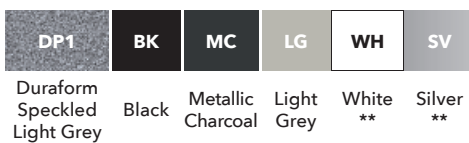

Duraform Speckled Light Grey

Black

Metallic Charcoal

Light Grey

White **

Silver **

5 Choose Your Edge Style

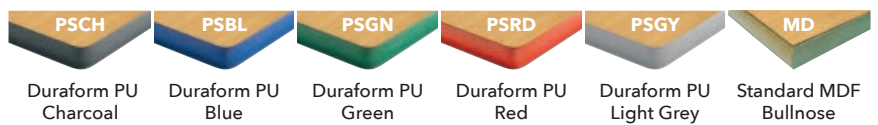

Duraform PU Charcoal

Duraform PU Blue

Duraform PU Green

Duraform PU Red

Duraform PU Light Grey

Standard MDF Bullnose

6 Choose Your Accessory (Optional Extra)



Tray Runners - CBSQ-TR



Table Trolley
Carries 6 tables at a time - TABLETRFB



Upright Table Trolley
Tilt, lift and move table trolley for easy transportation of up to 6 tables at a time - TABLETRSB



Crushed Bent Tables: Colour Collection

- ✓ Choose from a vibrant choice of 7 different colours.
- ✓ Supplied with a hard wearing 18mm MDF top and a sturdy Crushed Bent 25mm square tube frame.
- ✓ Stackable to 8 high for ease of storage.
- ✓ BSEN 1729 compliant.
- ✓ 5 year guarantee.



1 Choose Your Table

SHAPE	SIZE (L X W)	MDF EDGE CODE
Rectangular	1100 x 550mm	CBSQ-115-MD
Rectangular	1200 x 600mm	CBSQ-126-MD

2 Choose Your Table Height

HEIGHT	AGE RANGE
710mm	11-14 Years
760mm	14+ Years

3 Choose Your Laminate Colour



4 Choose Your Frame Colour



5 Choose Your Edge Style

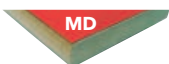

Standard MDF Bullnose

Images shown are for illustrative purposes only.
*Please note: matching table top colours and frame colours are similar in shade but not identical. Swatches can be provided for both upon request.
Orders are non-returnable.

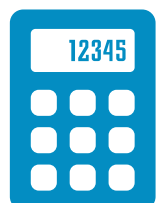

Elite Tables: Static Height & Height Adjustable

- ✓ Ultimate classroom range with both static and height adjustable options.
- ✓ Stylish oval tube frame.
- ✓ Height adjustable table for use with wheelchairs or where a versatile environment is required.
- ✓ 5 year guarantees.



Static Height: Rectangular**



Static Height: Semi-Circular**



Static Height: Trapezoidal**



Height Adjustable: Rectangular*



Height Adjustable: Semi-Circular*



Height Adjustable: Trapezoidal*



1 Choose Your Table

SHAPE	SIZE (L X W)	CODE
Static Height Table Rectangular**	1200 x 600mm	ELITE-126-PS
Static Height Table Semi-Circular**	1200mm Diameter	ELITE-12SC-PS
Static Height Table Trapezoidal**	1200 x 600mm	ELITE-12LE-PS
Height Adjustable Table Rectangular	1200 x 600mm	ELITE-ADJ-126-PS
Height Adjustable Table Semi-Circular	1200mm Diameter	ELITE-ADJ-12SC-PS
Height Adjustable Table Trapezoidal	1200 x 600mm	ELITE-ADJ-12LE-PS

2 Choose Your Static Table Height**

HEIGHT	AGE RANGE
710mm	11-14 Years
760mm	14+ Years



*Legs are adjustable with an Allen key between 710-1000mm.
 **Table heights are only available for Static Height Tables.
 ***Silver & White frames are non-returnable.

3 Choose Your Laminate Top Colour



4 Choose Your Frame Colour

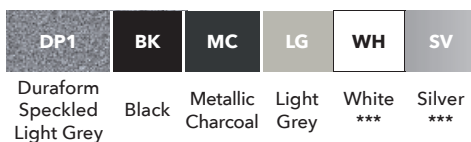

5 Choose Your Edge Style





Equation™ Tables

- ✓ Our exciting modular table range.
- ✓ Various shapes and colours are available.
- ✓ Premium finish with 25mm tops, Duraform edge and height adjustable feet.
- ✓ Stylish 32mm round frame tables with tamper proof fixings.
- ✓ BSEN 1729 compliant.
- ✓ 10 year guarantee.

Rectangular



Square



Stylish 32mm round tube frame

Trapezoidal



Premium finish with 25mm tops with a Duraform edge



Circular



Semi-Circular



Height adjustable feet



Arc*

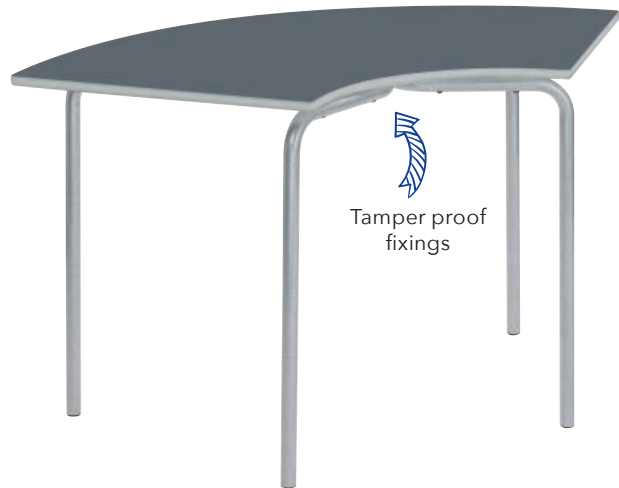

Tamper proof fixings





Equation™ Tables

- ✓ Our exciting modular table range.
- ✓ Various shapes and colours are available.
- ✓ Premium finish with 25mm tops, Duraform edge and height adjustable feet.
- ✓ Stylish 32mm round frame tables with tamper proof fixings.
- ✓ BSEN 1729 compliant.
- ✓ 10 year guarantee.

1 Choose Your Table

SHAPE	SIZE (L X W)	CODE
Rectangular	1100 x 550mm	EQUPR-115-PS
Rectangular	1200 x 600mm	EQUPR-126-PS
Square	600 x 600mm	EQUPR-66-PS
Trapezoidal	1100 x 550mm	EQUPR-11LE-PS
Trapezoidal	1200 x 600mm	EQUPR-12LE-PS
Circular	1100mm Diameter	EQUPR-11C-PS
Circular	1200mm Diameter	EQUPR-12C-PS
Semi-Circular	1200mm Diameter	EQUPR-12SC-PS
Arc	1490 x 600mm*	EQUPR-ARCV2-PS

*2100mm when 4 together to make a circular shape.
**Silver & White frames are non-returnable.

2 Choose Your Table Height

HEIGHT	AGE RANGE
710mm	11-14 Years
760mm	14 +

3 Choose Your Laminate Top Colour



4 Choose Your Frame Colour

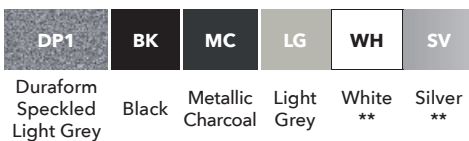

5 Choose Your Edge Style

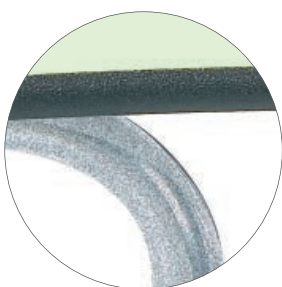

Duraform PU edge and premium 32mm round tube frame example





Equation™ Table: Leaf

- ✓ Stylish modular tables with ultimate versatility.
- ✓ Duraform PU edge and height adjustable feet as standard.
- ✓ Premium 32mm round tube frame with 25mm premium top.
- ✓ Various shapes and colours are available.
- ✓ BSEN 1729 compliant.
- ✓ 10 year guarantee.



Possible Shapes

Flower

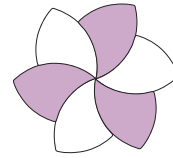

Circular*

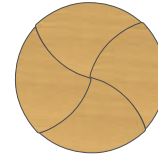

Fan



*4 tables together create a circular shape of 1750mm diameter.

1 Choose Your Table

SHAPE	SIZE (L X W)	CODE
Leaf	1220 x 870mm*	LEAF-PS

2 Choose Your Table Height

HEIGHT	AGE RANGE
710mm	11-14 Years
760mm	14 +

3 Choose Your Laminate Top Colour

BH Beech	CY Canary Yellow	GS Grey Speckle	LI Lilac	OF Orange Flame	PU Purple	SB Soft Blue	SLG Slate Grey	SL Soft Lime	TG Tangy Green	WH White
----------	------------------	-----------------	----------	-----------------	-----------	--------------	----------------	--------------	----------------	----------

4 Choose Your Frame Colour

DP1	BK	MC	LG	WH	SV
Duraform Speckled Light Grey	Black	Metallic Charcoal	Light Grey	White **	Silver **

5 Choose Your Edge Style

PSCH	PSBL	PSGN	PSRD	PSGY
Duraform PU Charcoal	Duraform PU Blue	Duraform PU Green	Duraform PU Red	Duraform PU Light Grey

**Silver & White frames are non-returnable.



Equation™ Table: Jewel

- ✓ Stylish modular tables with ultimate versatility.
- ✓ Duraform PU edge and height adjustable feet as standard.
- ✓ Premium 32mm round tube frame with 25mm premium top.
- ✓ Various shapes and colours are available.
- ✓ BSEN 1729 compliant.
- ✓ 10 year guarantee.



Possible Shapes

Star

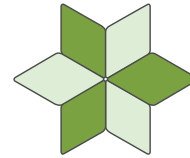

ZigZag

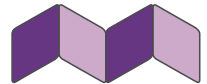

Hexagonal*

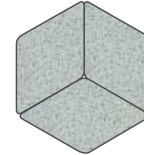

Line

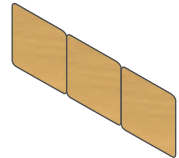

Diamond

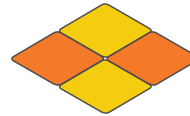

*3 tables together create a hexagonal shape of 1730mm diameter.

1 Choose Your Table

SHAPE	SIZE (L X W)	CODE
Jewel	1440 x 840mm	JEWEL-PS

2 Choose Your Table Height

HEIGHT	AGE RANGE
710mm	11-14 Years
760mm	14 +

3 Choose Your Laminate Top Colour

BH Beech	CY Canary Yellow	GS Grey Speckle	LI Lilac	OF Orange Flame	PU Purple	SB Soft Blue	SLG Slate Grey	SL Soft Lime	TG Tangy Green	WH White
----------	------------------	-----------------	----------	-----------------	-----------	--------------	----------------	--------------	----------------	----------

4 Choose Your Frame Colour

DP1	BK	MC	LG	WH	SV
Duraform Speckled Light Grey	Black	Metallic Charcoal	Light Grey	White **	Silver **

5 Choose Your Edge Style

PSCH	PSBL	PSGN	PSRD	PSGY
Duraform PU Charcoal	Duraform PU Blue	Duraform PU Green	Duraform PU Red	Duraform PU Light Grey

**Silver & White frames are non-returnable.



Euro Tables: Single, Double & Large Double

- ✓ Choose from three table sizes.
- ✓ 50 x 25mm steel tube frame.
- ✓ Solid 25mm MDF tops with a high pressure laminate.
- ✓ Choose from a vibrant choice of laminate and frame colours.
- ✓ 5 year guarantee.

Single



Double



1 Choose Your Table

SHAPE	SIZE (L X W)	MDF EDGE CODE	DURAFORM EDGE CODE
Single	600 x 600mm	EURO-66-MD	EURO-66-PS
Double	1200 x 600mm	EURO-126-MD	EURO-126-PS
Large Double	1500 x 750mm	EURO-157-MD	EURO-157-PS

2 Choose Your Table Height

HEIGHT	AGE RANGE
710mm	11-14 Years
760mm	14 +

3 Choose Your Laminate Top Colour



4 Choose Your Frame Colour

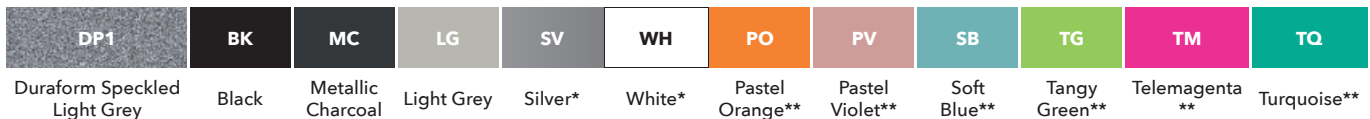

5 Choose Your Edge Style

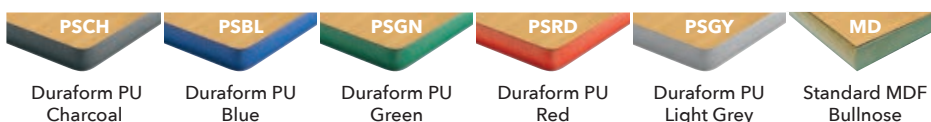

*Silver & White frames are non-returnable.
**Coloured frames are non refundable.



Exam Desks

- ✓ For all your examination needs.
- ✓ 20mm steel tube frame.
- ✓ Solid 18mm MDF tops with a high pressure laminate
- ✓ Pen groove included in price (unless specified otherwise).
- ✓ Stacking or folding options.
- ✓ MDF Bullnose polished and lacquered edge.
- ✓ 5 year guarantee.

Four Legged



Skid Legged Folding



Stacking*



Pen groove example

1 Choose Your Table

SHAPE	SIZE (L x W)	HEIGHT	MDF EDGE CODE
Four Legged Folding	600 x 600mm	710mm	EXMF4-MD
Skid Legged Folding	600 x 600mm	710mm	EXMFS-MD
Stacking*	600 x 500mm	710mm	EXMS-MD

2 Choose Your Laminate Top Colour



3 Choose Your Frame Colour

DP1	BK	MC	LG	WH	SV
Duraform Speckled Light Grey	Black	Metallic Charcoal	Light Grey	White **	Silver **

*Stackable up to 5 high.
**Silver & White frames are non-returnable.

4 Choose Your Edge Style

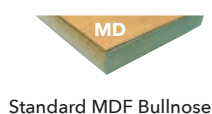

Standard MDF Bullnose

5 Choose Your Accessory (Optional Extra)



Exam Desk Trolley
Holds 24 Folding Exam Desks, 980 x 1050 x 670mm (H x W x D). Overall width is 1280mm including handles.
EXMTR



Fully Welded Tables

- ✓ Traditional Fully Welded tables with a quality finish.
- ✓ Rectangular table can be spirally stacked 6 high for ease of storage.
- ✓ BSEN 1729 compliant.
- ✓ 5 year guarantee.

Rectangular



Square



Sturdy 25mm square tube frame

Trapezoidal



Solid 18mm MDF tops with high pressure laminate



Circular



Semi-Circular



Polished and lacquered MDF Bullnose edge example

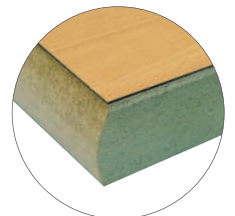

Duraform PU edge example

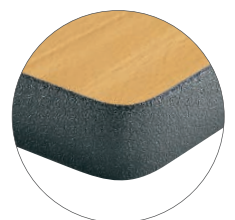



Fully Welded Tables

- ✓ Traditional Fully Welded tables with a quality finish.
- ✓ Rectangular table can be spirally stacked 6 high for ease of storage.
- ✓ BSEN 1729 compliant.
- ✓ 5 year guarantee.

1 Choose Your Table

SHAPE	SIZE (L X W)	MDF EDGE CODE	DURAFORM EDGE CODE
Rectangular	1100 x 550mm	SQSS-115-MD	SQSS-115-PS
Rectangular	1200 x 600mm	SQSS-126-MD	SQSS-126-PS
Square	600 x 600mm	SQSS-66-MD	SQSS-66-PS
Trapezoidal	1100 x 550mm	SQSS-11LE-MD	SQSS-11LE-PS
Trapezoidal	1200 x 600mm	SQSS-12LE-MD	SQSS-12LE-PS
Circular	1000mm Diameter	SQSS-10C-MD	SQSS-10C-PS
Circular	1100mm Diameter	SQSS-11C-MD	SQSS-11C-PS
Circular	1200mm Diameter	SQSS-12C-MD	SQSS-12C-PS
Semi-Circular	1100mm Diameter	SQSS-11SC-MD	SQSS-11SC-PS
Semi-Circular	1200mm Diameter	SQSS-12SC-MD	SQSS-12SC-PS

2 Choose Your Table Height

HEIGHT	AGE RANGE
710mm	11-14 Years
760mm	14 +

3 Choose Your Laminate Top Colour



4 Choose Your Frame Colour

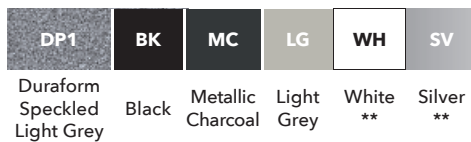

5 Choose Your Edge Style

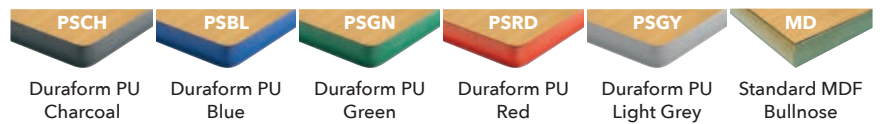

6 Choose Your Accessory (Optional Extra)



Tray Runners - SQSS-TR



Table Trolley
Carries 6 tables at a time - TABLETRFB



Upright Table Trolley
Tilt, lift and move table trolley for easy transportation of up to 6 tables at a time - TABLETRSB

**Silver & White frames are non-returnable.



Fully Welded Tables: BURO Edge

- ✓ Solid 18mm MDF tops with a high pressure laminate and 2mm BURO edge.
- ✓ Sturdy 25mm square tube frame.
- ✓ Rectangular can be spirally stacked 6 high for ease of storage.
- ✓ BSEN 1729 compliant.
- ✓ 5 year guarantee.

Rectangular



Square



Trapezoidal



1 Choose Your Table Shape

SHAPE	SIZE (L X W)	BURO EDGE CODE
Rectangular	1100 x 550mm	SQSS-115-B
Rectangular	1200 x 600mm	SQSS-126-B
Square	600 x 600mm	SQSS-66-B
Trapezoidal	1100 x 550mm	SQSS-11LE-B
Trapezoidal	1200 x 600mm	SQSS-12LE-B

2 Choose Your Table Height

HEIGHT	AGE RANGE
710mm	11-14 Years
760mm	14 +

3 Choose Your Laminate Top Colour



4 Choose Your Frame Colour

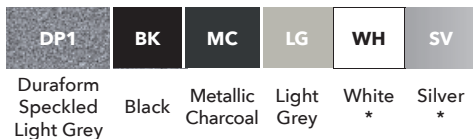

5 Choose Your BURO Edge Colour



*Silver & White frames are non-returnable.



BURO edge example

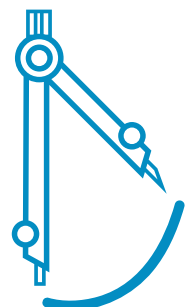



Fully Welded Tables: Colour Collection

- ✓ Choose from a vibrant choice of 7 different colours.
- ✓ Rectangular can be spirally stacked 6 high for ease of storage.
- ✓ Solid 18mm MDF tops with high pressure laminate.
- ✓ Sturdy 25mm square tube frame.
- ✓ BSEN 1729 compliant.
- ✓ 5 year guarantee.

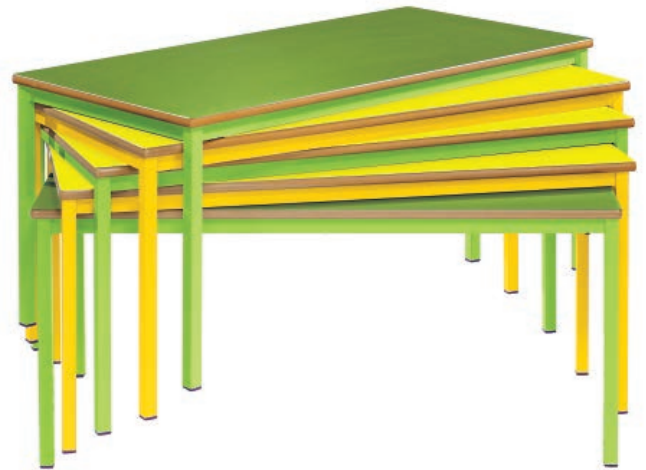

1 Choose Your Table

SHAPE	SIZE (L X W)	MDF EDGE CODE
Rectangular	1100 x 550mm	SQSS-115-MD
Rectangular	1200 x 600mm	SQSS-126-MD

2 Choose Your Table Height

HEIGHT	AGE RANGE
710mm	11-14 Years
760mm	14 +

3 Choose Your Laminate Colour



4 Choose Your Frame Colour*



5 Choose Your Edge Style

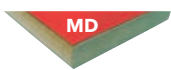

Standard MDF Bullnose

Images shown are for illustrative purposes only.
*Please note: matching table top colours and frame colours are similar in shade but not identical. Swatches can be provided for both upon request.
Orders are non-returnable.





Height Adjustable Table: HA200

- ✓ When height is set frames are completely tamper proof.
- ✓ Adjustable between 512-805mm.
- ✓ Side crank handle adjustable.
- ✓ Available with optional cable portholes.
- ✓ BSEN 1729 compliant.
- ✓ 5 year guarantee.



1 Choose Your HA200 Table

STYLE	SIZE (L X W)	CODE
Single	700 x 600mm	HA200/A-76
Single*	One central porthole - must be purchased at the same time as desk	P1
Double	1200 x 600mm	HA200/A-126
Double*	Two portholes - must be purchased at the same time as desk	P2

*Must be purchased at the same time as the desk.

2 Choose Your Laminate Top Colour



3 Choose Your Frame Colour



4 Choose Your Edge Style

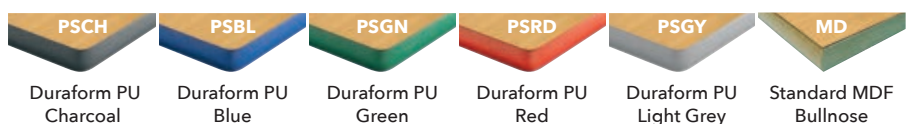



Height Adjustable Table: HA600

- ✓ Sit to stand height adjustment from 730mm to 1200mm.
- ✓ Available with single or double portholes*.
- ✓ 18mm MDF top with a high pressure laminate.
- ✓ 5 year guarantee.



Solid 18mm MDF tops with high pressure laminate



1 Choose Your HA600 Table

SIZE (L X W)	FRAME HEIGHT	CODE
1200 x 600mm	730mm to 1200mm	HA600/A-126
One central porthole - must be purchased at the same time as desk	-	P1
1200 x 750mm	730mm to 1200mm	HA600/A-127
Two portholes - must be purchased at the same time as desk	-	P2
1500 x 750mm	730mm to 1200mm	HA600/A-157



*Must be purchased at the same time as the desk.

2 Choose Your Laminate Top Colour



3 Choose Your Frame Colour

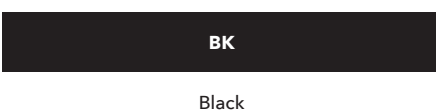

4 Choose Your Edge Style

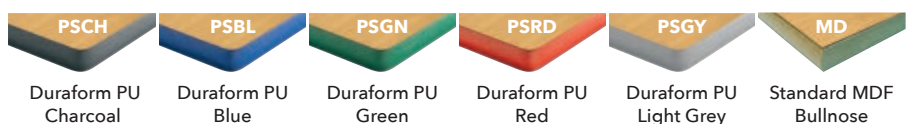



Meeting Room Tables

- ✓ Multiple room layout options possible.
- ✓ 45mm round chunky frame with a 25mm premium hard wearing top fitted as standard.
- ✓ 740mm height as standard.
- ✓ 10 year guarantee.

Rectangular



Square



Semi-Circular



Circular



Arc*



Possible Shapes

Circular*

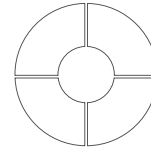

Square

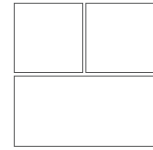

Meeting

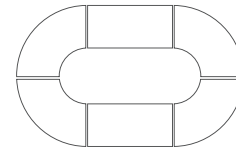

*2100mm when 4 together to make a circular shape.

1 Choose Your Table

SHAPE	SIZE (L X W)	MDF EDGE CODE	DURAFORM EDGE CODE
Rectangular	1200 x 600mm	MEET-126-MDP	MEET-126-PS
Square	600 x 600mm	MEET-66-MDP	MEET-66-PS
Semi-Circular	1200mm Dia.	MEET-12SC-MDP	MEET-12SC-PS
Circular	1000mm Dia.	MEET-10C-MDP	MEET-10C-PS
Circular	1200mm Dia.	MEET-12C-MDP	MEET-12C-PS
Arc	1490 x 600mm*	MEET-ARCV2-MDP	MEET-ARCV2-PS

2 Choose Your Table Height

HEIGHT	AGE RANGE
740mm	Office Height

**Silver & White frames are non-returnable.

3 Choose Your Laminate Top Colour



4 Choose Your Frame Colour

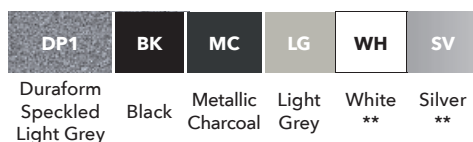

5 Choose Your Edge Style

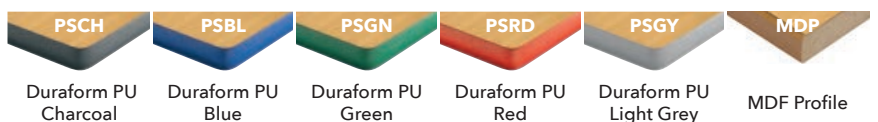



Premium Tilt Top Tables

- ✓ Smooth no-slam action.
- ✓ Superb strength and stability.
- ✓ Supplied 710mm high as standard with a Silver frame finish.
- ✓ 18mm MDF tops with a high pressure laminate.
- ✓ Designed and constructed to withstand the demands of the modern school and office.
- ✓ 5 year guarantee.

Rectangular



Circular



Supplied with locking castors

1 Choose Your Table Other sizes available on request.

SHAPE	SIZE (L x W)	HEIGHT	DURAFORM EDGE CODE
Rectangular	1200 x 600mm	710mm	PRTILT-126-PS
Rectangular	1500 x 750mm	710mm	PRTILT-157-PS
Rectangular	1600 x 800mm	710mm	PRTILT-168-PS
Rectangular	1800 x 800mm	710mm	PRTILT-188-PS
Circular	1100mm Diameter	710mm	PRTILT-11C-PS
Circular	1200mm Diameter	710mm	PRTILT-12C-PS

2 Choose Your Laminate Top Colour



3 Choose Your Frame Colour



4 Choose Your Edge Style

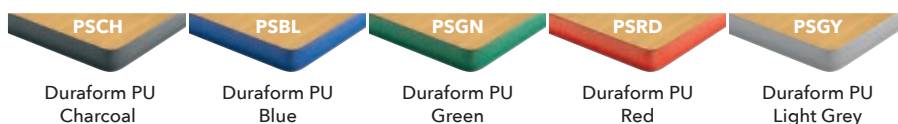



RT32 Tables

- ✓ Spiral stacking tables with premium round tube legs (32mm).
- ✓ Available in two different edge finishes.
- ✓ Solid 18mm MDF tops with a high pressure laminate.
- ✓ BSEN 1729 compliant.
- ✓ 5 year guarantee.

Rectangular



Square



Premium 32mm
round tube legs

Trapezoidal



Solid 18mm MDF tops
with high pressure
laminate



Circular



Semi-Circular



Arc*





RT32 Tables

- ✓ Spiral stacking tables with premium round tube legs (32mm).
- ✓ Available in two different edge finishes.
- ✓ Solid 18mm MDF tops with a high pressure laminate.
- ✓ BSEN 1729 compliant.
- ✓ 5 year guarantee.

Possible Shapes

Circular*

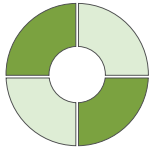

Square



Meeting

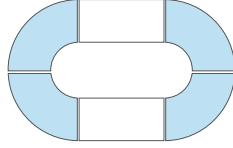

*2100mm when Arc 4 tables are together to make a circular shape.
**Silver & White frames are non-returnable.

1 Choose Your Table

SHAPE	SIZE (L X W)	MDF EDGE CODE	DURAFORM EDGE CODE
Rectangular	1100 x 550mm	RT32-115-MD	RT32-115-PS
Rectangular	1200 x 600mm	RT32-126-MD	RT32-126-PS
Rectangular	1500 x 750mm	RT32-157-MD	RT32-157-PS
Square	600 x 600mm	RT32-66-MD	RT32-66-PS
Square	750 x 750mm	RT32-77-MD	RT32-77-PS
Trapezoidal	1100 x 550mm	RT32-11LE-MD	RT32-11LE-PS
Trapezoidal	1200 x 600mm	RT32-12LE-MD	RT32-12LE-PS
Circular	1100mm Diameter	RT32-11C-MD	RT32-11C-PS
Circular	1200mm Diameter	RT32-12C-MD	RT32-12C-PS
Semi-Circular	1100mm Diameter	RT32-11SC-MD	RT32-11SC-PS
Semi-Circular	1200mm Diameter	RT32-12SC-MD	RT32-12SC-PS
Arc	1490 x 600mm*	RT32-ARCV2-MD	RT32-ARCV2-PS

2 Choose Your Table Height

HEIGHT	AGE RANGE
710mm	11-14 Years
760mm	14+ Years



3 Choose Your Laminate Top Colour

AI Ailsa	BH Beech	BL Blue	GN Green	LG Light Grey	MA Maple	OK Oak	SLG Slate Grey	RD Red	WH White	YE Yellow
----------	----------	---------	----------	---------------	----------	--------	----------------	--------	----------	-----------

4 Choose Your Frame Colour

DP1	BK	MC	LG	WH	SV
Duraform Speckled Light Grey	Black	Metallic Charcoal	Light Grey	White **	Silver **

5 Choose Your Edge Style

PSCH	PSBL	PSGN	PSRD	PSGY	MD
Duraform PU Charcoal	Duraform PU Blue	Duraform PU Green	Duraform PU Red	Duraform PU Light Grey	Standard MDF Bullnose

6 Choose Your Accessory (Optional Extra)



Tray Runners - RT32-TR



Table Trolley
Carries 6 tables at a time - TABLETRFB



Upright Table Trolley
Tilt, lift and move table trolley for easy transportation of up to 6 tables at a time - TABLETRSB



RT32 White Tables

- ✓ Versatile range that can be easily configured into any layout.
- ✓ 32mm round tubular frame.
- ✓ Solid 18mm MDF tops with a high pressure laminate and a matching white 2mm BURO edge.
- ✓ BSEN 1729 compliant.
- ✓ 5 year guarantee.

Rectangular



Square



Trapezoidal



1 Choose Your Table

SHAPE	SIZE (L X W)	BURO EDGE CODE
Rectangular	1100 x 550mm	RT32-115-B
Rectangular	1200 x 600mm	RT32-126-B
Rectangular	1500 x 750mm	RT32-157-B
Square	600 x 600mm	RT32-66-B
Square	750 x 750mm	RT32-77-B
Trapezoidal	1200 x 600mm	RT32-12LE-B

2 Choose Your Table Height

HEIGHT	AGE RANGE
710mm	11-14 Years
760mm	14+ Years

3 Choose Your Laminate Top Colour

WH White

Orders are non-returnable.

4 Choose Your Frame Colour

WH White

5 Choose Your Edge Colour

WHB White



RT45 Tables

- ✓ Solid 18mm MDF tops with a high pressure laminate.
- ✓ 45mm round chunky tubular frame.
- ✓ Versatile range that can be easily configured into any layout.
- ✓ 5 year guarantee.

Rectangular



Square



Semi-Circular



Circular



Arc*



Possible Shapes

Circular*

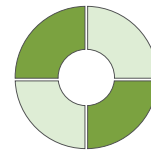

Square



Meeting

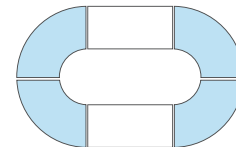

*2100mm when 4 together to make a circular shape.

**Silver & White frames are non-returnable.

1 Choose Your Table

SHAPE	SIZE (L X W)	MDF EDGE CODE	DURAFORM EDGE CODE
Arc	1490 x 600mm*	RT45-ARCV2-MD	RT45-ARCV2-PS
Square	600 x 600mm	RT45-66-MD	RT45-66-PS
Circular	1000mm Diameter	RT45-10C-MD	RT45-10C-PS
Circular	1200mm Diameter	RT45-12C-MD	RT45-12C-PS
Semi-Circular	1200mm Diameter	RT45-12SC-MD	RT45-12SC-PS
Rectangular	1200 x 600mm	RT45-126-MD	RT45-126-PS

2 Choose Your Table

HEIGHT	AGE RANGE
710mm	11-14 Years
760mm	14 +

3 Choose Your Laminate Top Colour



4 Choose Your Frame Colour

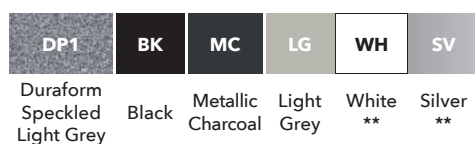

5 Choose Your Edge Style

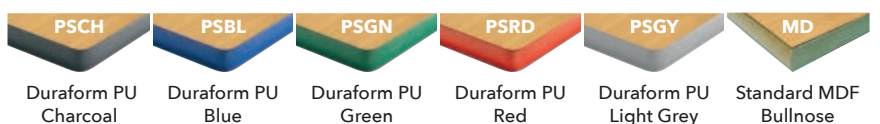



Shaped Table: Connect

- ✓ Flexible and dynamic modular table with endless tessellation possibilities.
- ✓ Sturdy 32mm Fully Welded frame with 18mm MDF top.
- ✓ Designed to seat 1 but can seat 3 when a full working space is not essential.
- ✓ Perfect for Communal Areas.
- ✓ 5 year guarantee.



Possible Shapes

Line

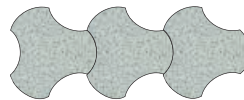

3

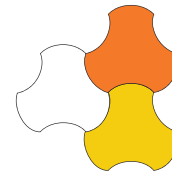

Circle Gap

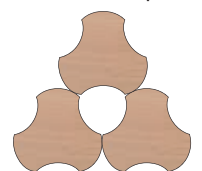

1 Choose Your Table

SIZE (L X W)	CODE
940 x 890mm	CON-M-PS

2 Choose Your Table

HEIGHT	AGE RANGE
710mm	11-14 Years
760mm	14 +

*Silver & White frames are non-returnable.

3 Choose Your Laminate Top Colour

BH Beech	CY Canary Yellow	GS Grey Speckle	LI Lilac	OF Orange Flame	PU Purple	SB Soft Blue	SLG Slate Grey	SL Soft Lime	TG Tangy Green	WH White
-----------------	-------------------------	------------------------	-----------------	------------------------	------------------	---------------------	-----------------------	---------------------	-----------------------	-----------------

4 Choose Your Frame Colour

DP1	BK	MC	LG	WH	SV
Duraform Speckled Light Grey	Black	Metallic Charcoal	Light Grey	White *	Silver *

5 Choose Your Edge Style

PSCH	PSBL	PSGN	PSRD	PSGY
Duraform PU Charcoal	Duraform PU Blue	Duraform PU Green	Duraform PU Red	Duraform PU Light Grey

Shaped Table: Segga

- ✓ Sturdy 32mm Fully Welded frame with 18mm laminate top.
- ✓ Stylish modular table with multiple shape combinations possible.
- ✓ Ultimate flexibility for any Classroom, Project or Library.
- ✓ Perfect for creating ICT hot desks.
- ✓ 5 year guarantee.



Possible Shapes

S

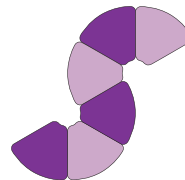

Circle*

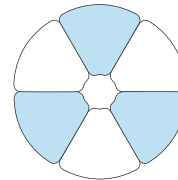

Semi-Circle

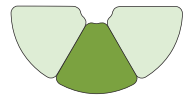

1 Choose Your Table

SIZE (L X W)	CODE
755 x 660mm*	SEG-S-PS

2 Choose Your Table

HEIGHT	AGE RANGE
710mm	11-14 Years
760mm	14 +

*6 tables together create a circular shape of 1635mm diameter.
**Silver & White frames are non-returnable.

3 Choose Your Laminate Top Colour

BH Beech	CY Canary Yellow	GS Grey Speckle	LI Lilac	OF Orange Flame	PU Purple	SB Soft Blue	SLG Slate Grey	SL Soft Lime	TG Tangy Green	WH White
-----------------	-------------------------	------------------------	-----------------	------------------------	------------------	---------------------	-----------------------	---------------------	-----------------------	-----------------

4 Choose Your Frame Colour

DP1	BK	MC	LG	WH	SV
Duraform Speckled Light Grey	Black	Metallic Charcoal	Light Grey	White **	Silver **

5 Choose Your Edge Style

PSCH	PSBL	PSGN	PSRD	PSGY
Duraform PU Charcoal	Duraform PU Blue	Duraform PU Green	Duraform PU Red	Duraform PU Light Grey



Teachers Desks: Crushed Bent & Fully Welded

- ✓ Choose from two popular frame styles.
- ✓ Teachers desks are supplied to match our core table ranges.
- ✓ Select either a 2 drawer or 3 drawer option (top drawer is lockable).
- ✓ Supplied with two sets of keys per table ordered.
- ✓ 5 year guarantee.

Crushed Bent Teachers Desk

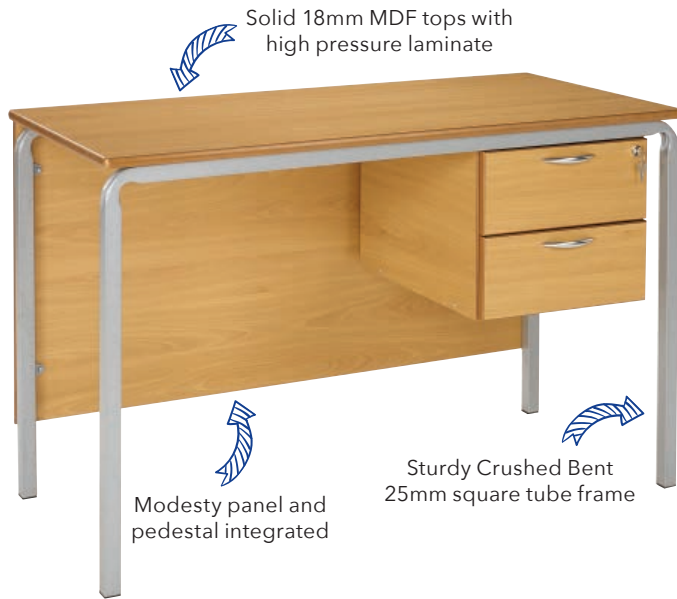

Fully Welded Teachers Desk



1 Choose Your Table

TABLE STYLE	DRAWERS	SIZE (L x W)	MDF EDGE CODE	DURAFORM EDGE CODE
Crushed Bent	2	1200 x 600mm	CBTD2-126-MD	CBTD2-126-PS
Crushed Bent	3	1200 x 600mm	CBTD3-126-MD	CBTD3-126-PS
Fully Welded	2	1200 x 600mm	SQTD2-126-MD	SQTD2-126-PS
Fully Welded	3	1200 x 600mm	SQTD3-126-MD	SQTD3-126-PS

2 Choose Your Desk Height

HEIGHT
710mm
720mm
760mm

3 Choose Your Laminate Top Colour



4 Choose Your Frame Colour

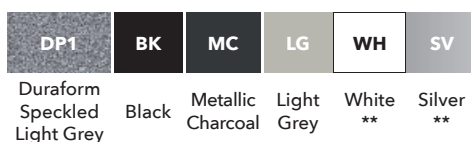

5 Choose Your Edge Style

**Silver & White frames are non-returnable.

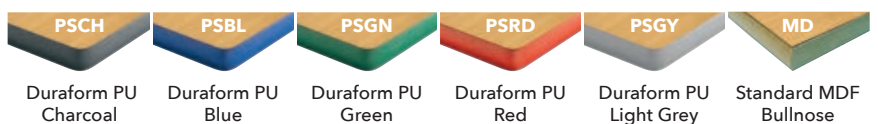



Teachers Desk: RT45 Premium

- ✓ Premium 45mm round chunky tubular frame.
- ✓ Solid 18mm MDF tops with a high pressure laminate.
- ✓ Matching laminate tops and edges.
- ✓ Vibrant choice of frames.
- ✓ Supplied with two sets of keys (top drawer is lockable).
- ✓ 5 year guarantee.



Modesty panel and pedestal integrated

Choose from vibrant frame colours



Choose from 2 drawer or 3 drawer options



Supplied with a matching 2mm ABS edge



1 Choose Your Table

DRAWERS	SIZE (L x W)	CODE
2	1200 x 600mm	RT45TD-2-126-B
2	1500 x 750mm	RT45TD-2-157-B
3	1200 x 600mm	RT45TD-3-126-B
3	1500 x 750mm	RT45TD-3-157-B

2 Choose Your Desk Height

HEIGHT
710mm
720mm
760mm

3 Choose Your Frame Colour

PO Pastel Orange	PV Pastel Violet	SB Soft Blue	SL Soft Lime	TG Tangy Green	TM Telemagenta	TQ Turquoise	BK Black	DP1 Duraform Speckled Light Grey
----------------------------	----------------------------	------------------------	------------------------	--------------------------	--------------------------	------------------------	--------------------	---

4 Choose Your Laminate Top Colour

BHB Beech	LG Light Grey	MAB Maple	WHB White
------------------	----------------------	------------------	------------------

5 Choose Your Edge Style

BHB Beech	GRB Light Grey	MAB Maple	WHB White
------------------	-----------------------	------------------	------------------



White Board Top Tables

- ✓ Hard wearing 18mm high gloss white top.
- ✓ High scratch resistant.
- ✓ Promotes a paperless environment.
- ✓ Available on all table sizes.
- ✓ Wipe clean free surface.
- ✓ Excellent for brainstorming ideas.

Segga Table



Fully Welded Rectangular



Fully Welded Square



Fully Welded Circular



1 Choose Your Table Shape

SHAPE	SIZE (L x W)	CODE
Segga	755 x 660mm	SEG-S-WHWB-PS
Fully Welded Rectangular	1100 x 550mm	SQSS-115-WHWB-PS
Fully Welded Rectangular	1200 x 600mm	SQSS-126-WHWB-PS
Fully Welded Square	600 x 600mm	SQSS-66-WHWB-PS
Fully Welded Circular	1000mm Diameter	SQSS-10C-WHWB-PS
Fully Welded Circular	1100mm Diameter	SQSS-11C-WHWB-PS
Fully Welded Circular	1200mm Diameter	SQSS-12C-WHWB-PS

2 Choose Your Table Height

HEIGHT	AGE RANGE
710mm	11-14 Years
760mm	14 +

*Silver & White frames are non-returnable.

Always use whiteboard approved pens and clean using whiteboard approved solution.

Orders are non-returnable.

3 Choose Your Frame Colour

DP1	BK	MC	LG	WH	SV
Duraform Speckled Light Grey	Black	Metallic Charcoal	Light Grey	White *	Silver *

4 Choose Your Edge Style

PSCH	PSBL	PSGN	PSRD	PSGY
Duraform PU Charcoal	Duraform PU Blue	Duraform PU Green	Duraform PU Red	Duraform PU Light Grey

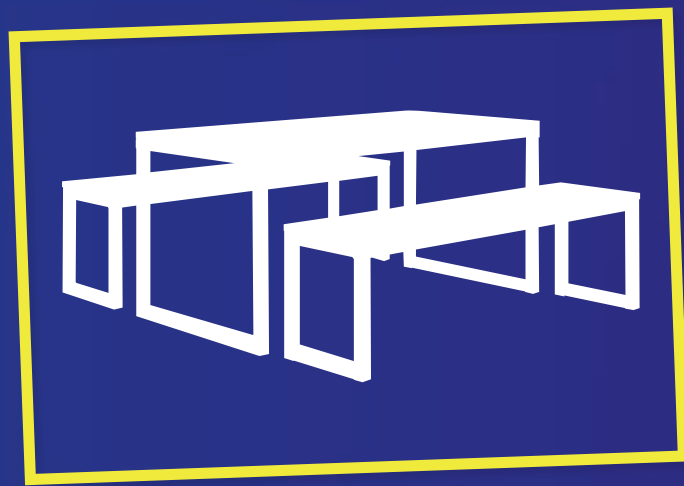

Dining



Four Seater Bench

- ✓ Ideal for use in Canteen areas.
- ✓ Solid 25mm table top.
- ✓ Sturdy steel frame coated in hard wearing paint.
- ✓ Double entry use.
- ✓ 40 x 40mm square tube frame.
- ✓ 2 year guarantee.

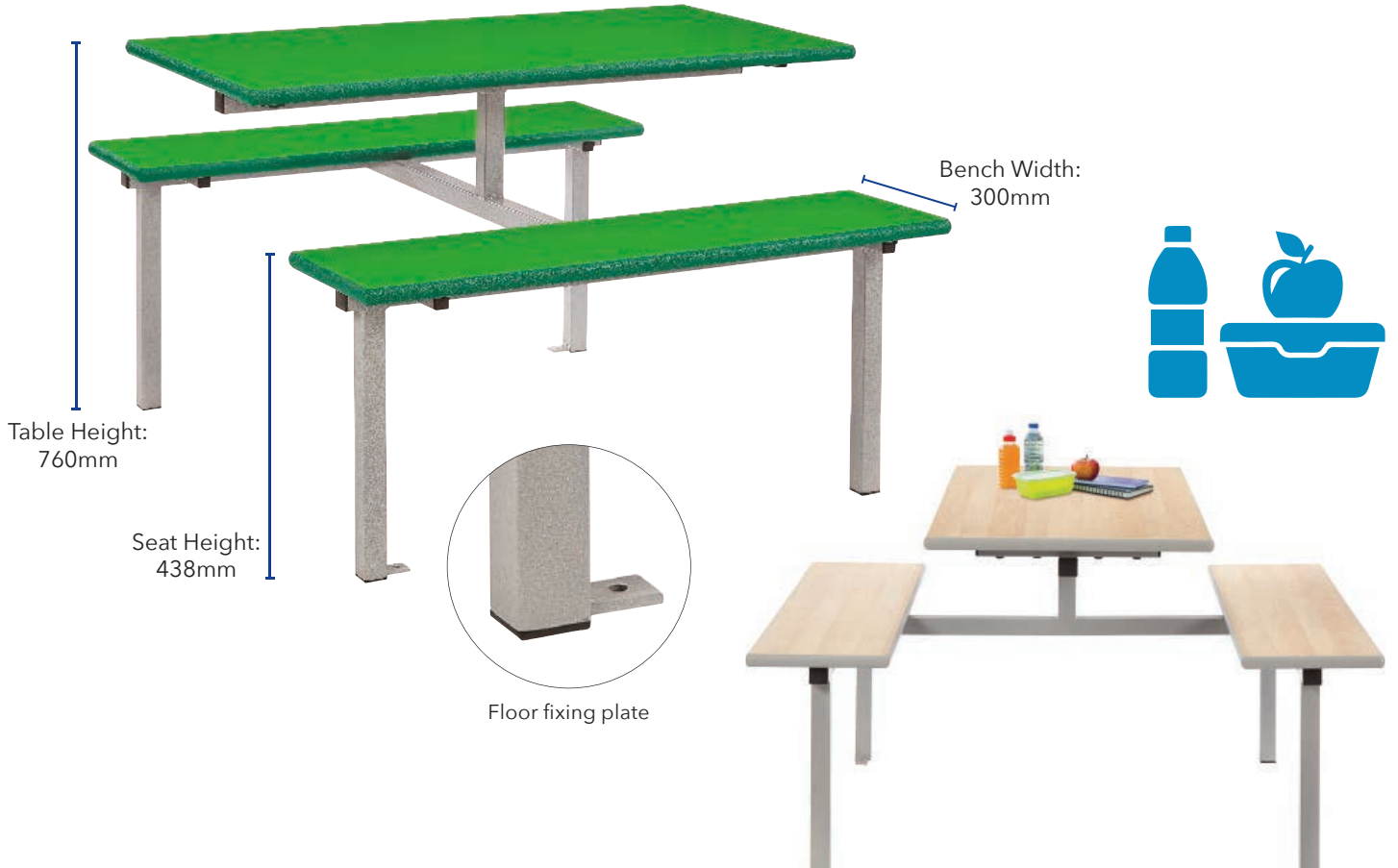

1 Choose Your Dining Table

OVERALL SIZE (L x W)	TABLE SIZE (L x W)	SEAT HEIGHT	CODE
1200 x 1240mm	1200 x 600mm	438mm	CAN-WOODMID

2 Choose Your Laminate Top Colour

AI Ailsa	BH Beech	BL Blue	GN Green	LG Light Grey	MA Maple	OK Oak	SLG Slate Grey	RD Red	WH White	YE Yellow
----------	----------	---------	----------	---------------	----------	--------	----------------	--------	----------	-----------

3 Choose Your Frame Colour

DP1	BK	MC	LG	WH	SV
Duraform Speckled Light Grey	Black	Metallic Charcoal	Light Grey	White	Silver

4 Choose Your Edge Style

PSCH	PSBL	PSGN	PSRD	PSGY	MD
Duraform PU Charcoal	Duraform PU Blue	Duraform PU Green	Duraform PU Red	Duraform PU Light Grey	Standard MDF Bullnose

Please Note: Legs need to be bolted to the floor using the two fixing plates supplied before use. Delivered fully assembled.

Orders are non-returnable.



Four Seater Canteen Table & NP Chairs

- ✓ Ideal for use in Canteen areas.
- ✓ Solid 25mm table top.
- ✓ Sturdy steel frame coated in hard wearing paint.
- ✓ Double or single entry available.
- ✓ 2 year guarantee.



1 Choose Your Dining Table

OVERALL SIZE (L x W)	TABLE SIZE (L X W)	SEAT HEIGHT	CODE
1200 x 1492mm	1200 x 600mm	460mm	CAN-4SEATERMID

2 Choose Your Shell Colour

BL Blue	CH Charcoal	GN Green	LI Lilac	OR Orange	PU Purple	RD Red	SB Soft Blue	TG Tangy Green	YE Yellow	BK Black	WH White
----------------	--------------------	-----------------	-----------------	------------------	------------------	---------------	---------------------	-----------------------	------------------	-----------------	-----------------

3 Choose Your Laminate Top Colour

AI Ailsa	BH Beech	BL Blue	GN Green	LG Light Grey	MA Maple	OK Oak	SLG Slate Grey	RD Red	WH White	YE Yellow
-----------------	-----------------	----------------	-----------------	----------------------	-----------------	---------------	-----------------------	---------------	-----------------	------------------

4 Choose Your Frame Colour

DP1	BK	MC	LG	WH	SV
Duraform Speckled Light Grey	Black	Metallic Charcoal	Light Grey	White	Silver

5 Choose Your Edge Style

PSCH	PSBL	PSGN	PSRD	PSGY	MD
Duraform PU Charcoal	Duraform PU Blue	Duraform PU Green	Duraform PU Red	Duraform PU Light Grey	Standard MDF Bullnose

Delivered fully assembled.

Please Note: Legs need to be bolted to the floor using the two fixing plates supplied before use.

Orders are non-returnable.



Four Seater Cantilever Table & NP Chairs

- ✓ Ideal for use in Canteen areas.
- ✓ Solid 25mm table top.
- ✓ Sturdy steel frame coated in hard wearing paint.
- ✓ Single entry only.
- ✓ 2 year guarantee.



1

OVERALL SIZE (L x W)	TABLE SIZE (L X W)	SEAT HEIGHT	CODE
1200 x 1492mm	1200 x 600mm	460mm	CAN-4SEATEREND

2 Choose Your Shell Colour

BL Blue	CH Charcoal	GN Green	LI Lilac	OR Orange	PU Purple	RD Red	SB Soft Blue	TG Tangy Green	YE Yellow	BK Black	WH White
---------	-------------	----------	----------	-----------	-----------	--------	--------------	----------------	-----------	----------	----------

3 Choose Your Laminate Top Colour

AI Ailsa	BH Beech	BL Blue	GN Green	LG Light Grey	MA Maple	OK Oak	SLG Slate Grey	RD Red	WH White	YE Yellow
----------	----------	---------	----------	---------------	----------	--------	----------------	--------	----------	-----------

4 Choose Your Frame Colour

DP1	BK	MC	LG	WH	SV
Duraform Speckled Light Grey	Black	Metallic Charcoal	Light Grey	White	Silver

5 Choose Your Edge Style

PSCH	PSBL	PSGN	PSRD	PSGY	MD
Duraform PU Charcoal	Duraform PU Blue	Duraform PU Green	Duraform PU Red	Duraform PU Light Grey	Standard MDF Bullnose

Please Note: Legs need to be bolted to the floor using the two fixing plates supplied before use.

Delivered fully assembled.
Orders are non-returnable.



Standard Dining Tables & Benches

- ✓ Bench style dining sets.
- ✓ Set comprises of two benches and a table.
- ✓ 25mm MDF table top with a BURO edge.
- ✓ Chunky 40 x 40mm box section vibrant coloured frame.
- ✓ Benches store underneath the table for a tidy environment.
- ✓ 5 year guarantee.



Table Height:
760mm

Bench Height:
450mm

1 Choose Your Dining Table

TABLE SIZE (L X W X H)	BENCH SIZE (L X W X H)	QUANTITY	CODE
1600 x 800 x 760mm	1400 x 400 x 450mm	1x Table and 2x Benches	STDINING-168-B
1800 x 800 x 760mm	1600 x 400 x 450mm	1x Table and 2x Benches	STDINING-188-B
2000 x 800 x 760mm	1800 x 400 x 450mm	1x Table and 2x Benches	STDINING-208-B
2200 x 800 x 760mm	2000 x 400 x 450mm	1x Table and 2x Benches	STDINING-228-B

2 Choose Your Frame Colour

PO Pastel Orange	PV Pastel Violet	SB Soft Blue	SL Soft Lime	TG Tangy Green	TM Telemagenta	TQ Turquoise
----------------------------	----------------------------	------------------------	------------------------	--------------------------	--------------------------	------------------------

3 Choose Your Laminate

WH White	BH Beech
-----------------	-----------------

4 Choose Your BURO Edge Colour

WHB White	BH Beech
------------------	-----------------

Orders are non-returnable.



Tilt Top Dining Tables

- ✓ Perfect for regular use in Dining Rooms.
- ✓ Easy to open and close then wheel away and store.
- ✓ Supplied with 4 locking castors.
- ✓ 30 x 30mm square tube frame.
- ✓ 5 year guarantee.

Rectangular



Circular



Oval



Equal Octagonal



Irregular Octagonal



1 Choose Your Dining Table

SHAPE	SIZE (L x W)	MDF EDGE CODE	DURAFORM EDGE CODE
Circular	1200mm Diameter	TILT-CIRC-MD	TILT-CIRC-PS
Oval	1610 x 900mm	TILT-OV-MD	TILT-OV-PS
Equal Octagonal	1200 x 1200mm	TILT-EQOCT-MD	TILT-EQOCT-PS
Irregular Octagonal	1380 x 1000mm	TILT-OCT-MD	TILT-OCT-PS
Rectangular	1200 x 900mm	TILT-129-MD	TILT-129-PS
Rectangular	1500 x 900mm	TILT-159-MD	TILT-159-PS

2 Choose Your Table Height

HEIGHT	AGE RANGE
710mm	11-14 Years
760mm	14 +

3 Choose Your Laminate Top Colour



4 Choose Your Frame Colour

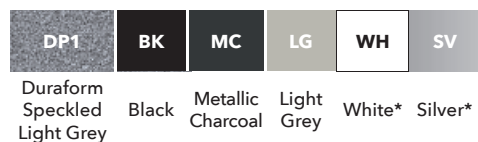

5 Choose Your Edge Style

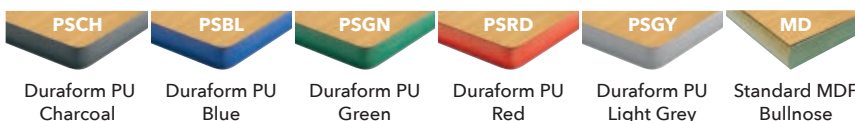

*Silver & White frames are non-returnable.



Two Seater Canteen Table & NP Chair

- ✓ Ideal for use in Canteen areas.
- ✓ Solid 25mm table top.
- ✓ Sturdy steel frame coated in hard wearing paint.
- ✓ Single entry only.
- ✓ 2 year guarantee.



1 Choose Your Dining Table

OVERALL SIZE (L x W)	TABLE SIZE (L X W)	SEAT HEIGHT	CODE
1492 x 600mm	600 x 600mm	460mm	CAN-2SEATER

2 Choose Your Shell Colour

BL Blue	CH Charcoal	GN Green	LI Lilac	OR Orange	PU Purple	RD Red	SB Soft Blue	TG Tangy Green	YE Yellow	BK Black	WH White
----------------	--------------------	-----------------	-----------------	------------------	------------------	---------------	---------------------	-----------------------	------------------	-----------------	-----------------

3 Choose Your Laminate Top Colour

AI Ailsa	BH Beech	BL Blue	GN Green	LG Light Grey	MA Maple	OK Oak	SLG Slate Grey	RD Red	WH White	YE Yellow
-----------------	-----------------	----------------	-----------------	----------------------	-----------------	---------------	-----------------------	---------------	-----------------	------------------

4 Choose Your Frame Colour

DP1	BK	MC	LG	WH	SV
Duraform Speckled Light Grey	Black	Metallic Charcoal	Light Grey	White	Silver

5 Choose Your Edge Style

PSCH	PSBL	PSGN	PSRD	PSGY	MD
Duraform PU Charcoal	Duraform PU Blue	Duraform PU Green	Duraform PU Red	Duraform PU Light Grey	Standard MDF Bullnose



Extras

Storage Tray Racks

- ✓ Brighten up your classroom with these modern units.
- ✓ The most robust tray storage system around (trays supplied separately).
- ✓ Supplied fully assembled static or mobile available.
- ✓ Swap the MDF top for a metal insert top for an additional cost.
- ✓ Duraform Speckled Light Grey frame paint.
- ✓ 10 year guarantee.



1 Column, 6 Trays



2 Columns, 12 Trays



3 Columns, 24 Trays



3 Columns, 27 Trays



2 Columns, 36 Trays*



3 Columns, 54 Trays*



*Supplied static only. Trays are sold separately. Gratnell coloured trays can be supplied as a 'match n mix colour selection' or 'matched to your own colour combination' options. Other Storage Tray Rack heights and sizes are available upon request. See page 63 for tray options.

1 Choose Your Storage Tray Rack

STORAGE TRAY RACK	SIZE (H X L X W)	CODE
1 Column, 6 Trays	610 x 366 x 435mm	8006
2 Columns, 12 Trays	610 x 705 x 435mm	8012
3 Columns, 24 Trays	770 x 1048 x 435mm	8024
3 Columns, 27 Trays	850 x 1048 x 435mm	8027
2 Columns, 36 Trays*	1550 x 705 x 435mm	8036
3 Columns, 54 Trays*	1550 x 1048 x 435mm	8054

2 Choose Your Laminate Top Colour



3 Choose Your Frame Colour



Duraform Speckled Light Grey

4 Choose Your Edge Style

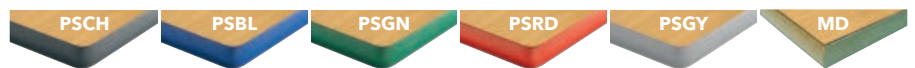

Duraform PU Charcoal

Duraform PU Blue

Duraform PU Green

Duraform PU Red

Duraform PU Light Grey

Standard MDF Bullnose



Wooden Tray Units

- ✓ Choose from a wide range of storage tray unit sizes.
- ✓ Unit supplied fully assembled with castors as standard.
- ✓ The perfect storage solution for the modern classroom environment.
- ✓ Supplied with an 18mm Beech MFC carcass.
- ✓ Compatible with single trays (sold separately).
- ✓ 2 year guarantee.

1 Column, 6 Trays



1 Column, 8 Trays



2 Columns, 12 Trays



2 Columns, 16 Trays



3 Columns, 12 Trays



3 Columns, 18 Trays



3 Columns, 24 Trays



Castor example

Trays are sold separately. Grannell coloured trays can be supplied as a 'match n mix colour selection' or 'matched to your own colour combination' options. See page 63 for tray options. **Orders are non-returnable.**

1 Choose Your Tray Unit

WOODEN TRAY UNIT	SIZE (H X L X W)	CODE
1 Column, 6 Trays	662 x 357 x 475mm	TRWOOD6(1X6)
1 Column, 8 Trays	850 x 357 x 475mm	TRWOOD8(1X8)
2 Columns, 12 Trays	662 x 692 x 475mm	TRWOOD12(2X6)
2 Columns, 16 Trays	850 x 692 x 475mm	TRWOOD16(2X8)
3 Columns, 12 Trays	474 x 1030 x 475mm	TRWOOD12(3X4)
3 Columns, 18 Trays	662 x 1030 x 475mm	TRWOOD18(3X6)
3 Columns, 24 Trays	850 x 1030 x 475mm	TRWOOD24(3X8)

2 Choose Your BURO Edge Colour





Trays

- ✓ Vibrant choice of tray colours.
- ✓ Choose from single, deep and jumbo tray sizes.
- ✓ Match or 'mix n match' tray colours and sizes.

1 Choose Your Tray Size

Single Tray

SUB-TRAY-STD

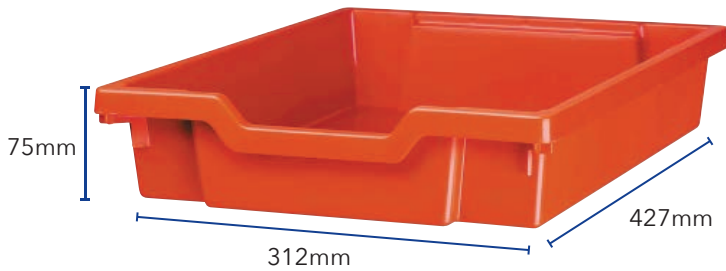

Deep Tray

SUB-TRAY-DP

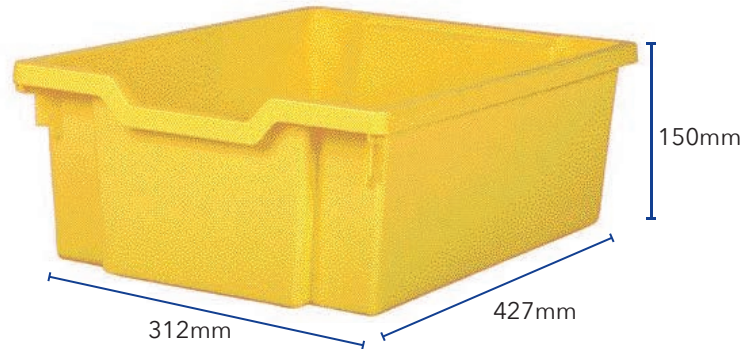

Jumbo Tray

SUB-TRAY-JU



2 Choose Your Tray Colour



CG Charcoal Grey*



GG Grass Green



FR Flame Red



PL Plum Purple



RB Royal Blue



SY Sunshine Yellow

Trays are sold separately. Grattell coloured trays can be supplied as a 'match n mix colour selection' or 'matched to your own colour combination' options. Other tray colours are available on request. *Not available in Jumbo Tray size. **Orders are non-returnable.**

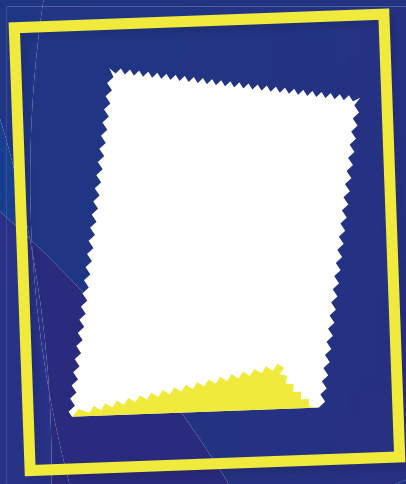

Swatches

Edges, Tops, Frames, Shells & Fabric Colours

Edge Styles

DURAFORM PU



Duraform PU - Charcoal
(Hardwearing & Durable)



Duraform PU - Light Grey
(Hardwearing & Durable)



Duraform PU - Blue
(Hardwearing & Durable)



Duraform PU - Green
(Hardwearing & Durable)



Duraform PU - Red
(Hardwearing & Durable)

Extremely flexible as it can be used on any shape or size table. | Extremely hardwearing. | Impact resistant. | Environmentally friendly, as when compared to traditional PU less is required to achieve the same outstanding results. | Waterproof. | Modern. | Supplied on an MDF core for added strength and durability. | Available on 18mm and 25mm tops.

MDF



MDF Bullnose



Standard MDF Profile*

Polished and lacquered. | Available on 18mm and 25mm tops. | *Supplied as standard on meeting tables.

ABS



Light Grey

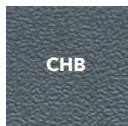

Charcoal

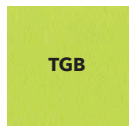

Tangy Green



Yellow



Maple



Green



Blue

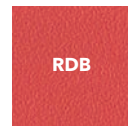

Red



Beech

Used on MFC Core or MDF. | 2mm strip edging. | Known as BURO edging. | Available in 18mm as standard. | Available only on rectangular and square tables.

Top Styles

WHITE BOARD TOP



WHWB

WHITE



White board tops available on all table ranges.

Always use whiteboard approved pens and clean using whiteboard approved solution.



Available on 18mm and 25mm tops. | High scratch resistant. | Wipe clean free surface. | Supplied with a spray PU edge.

STANDARD LAMINATES



RD

Red



GN

Green



BL

Blue



BH

Beech



YE

Yellow



MA

Maple



OK

Oak



LG

Light Grey

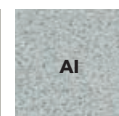

AI

Ailsa



SLG

Slate Grey

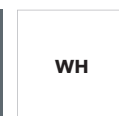

WH

White

Edges, Tops, Frames, Shells & Fabric Colours

Top Styles

PREMIUM LAMINATES

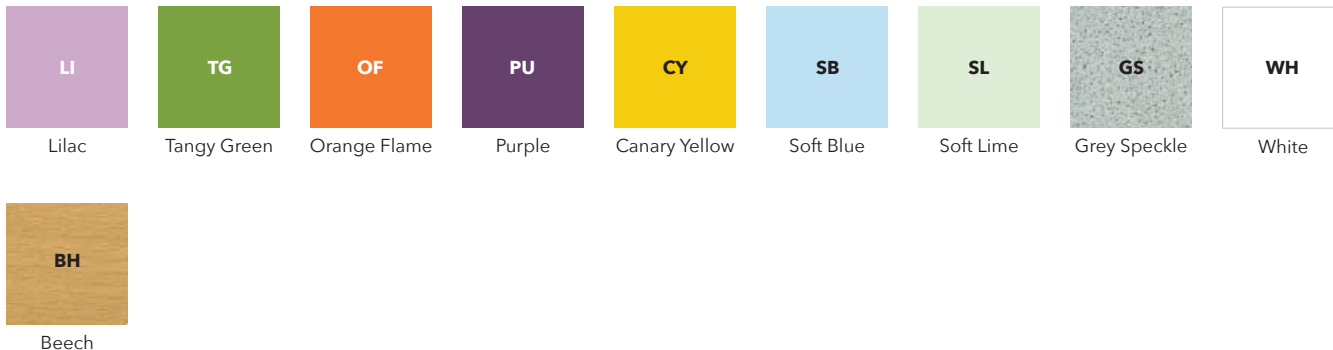

TRESPA



16mm thickness. | Heavy duty. | Moisture resistant. | Scratch and wear resistant. | Antibacterial properties. | Impact resistant. | Easy to clean. | 24hr chemical resistance. | Suitable for contact with food. | 10 year guarantee.

Frame Options

STANDARD FRAMES

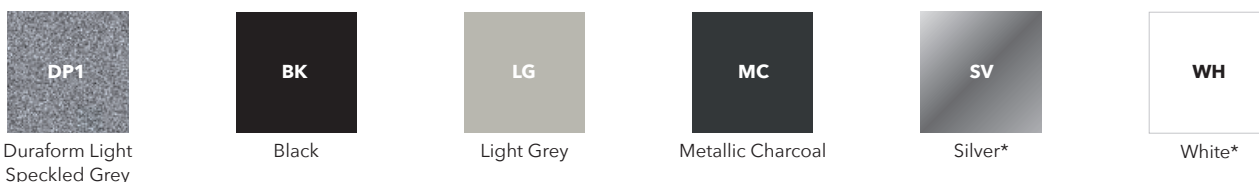

PREMIUM FRAMES



*Non-returnable.

Edges, Tops, Frames, Shells & Fabric Colours

Chair Shells

STANDARD CHAIR SHELLS

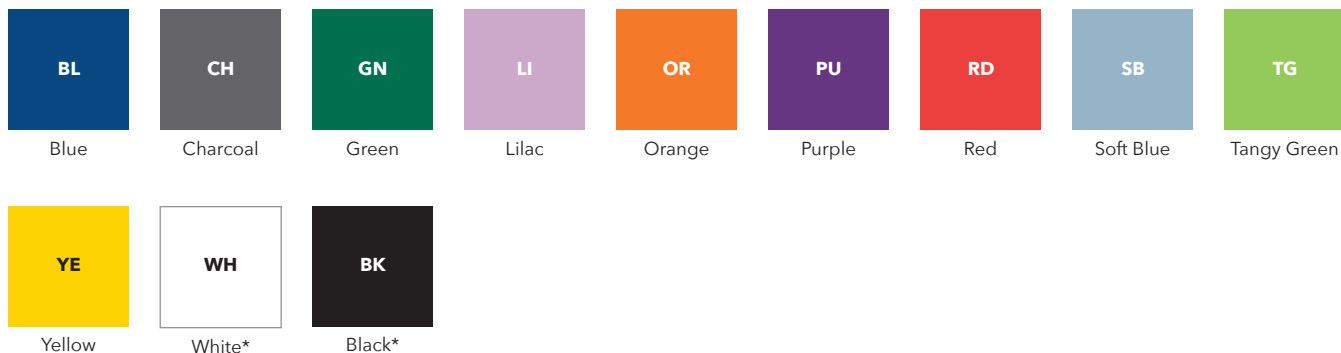

Available for ST, NP, BS, Chair 2000 skid base and four legged chairs. *Available on NP Chairs only.

OTHER CHAIR SHELLS

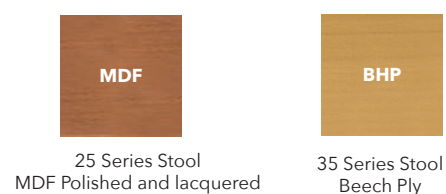

Fabrics

UPHOLSTERED CHAIR FABRICS

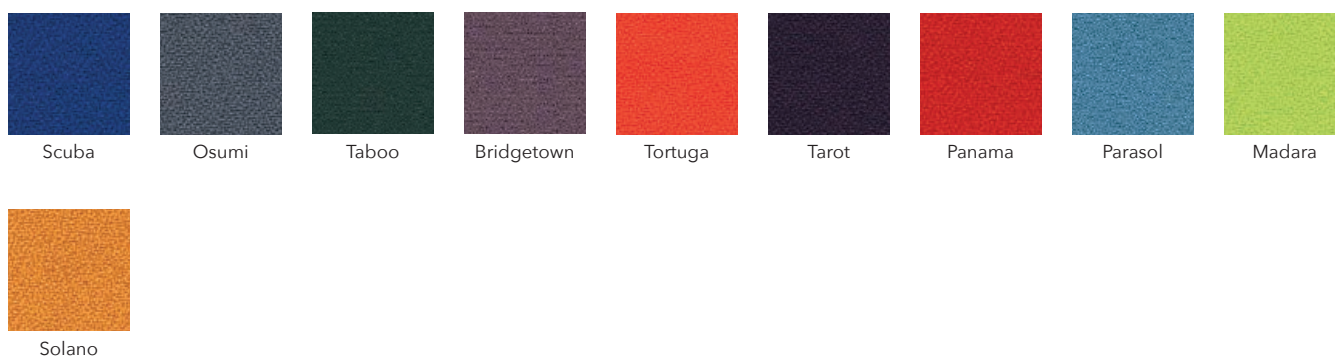

Available as seat pads and back pads for ST, NP, Chair 2000 skid base and four legged chairs.



Inspirational Educational Furniture



-  01623 427 596
-  sales@winscombefurniture.com
-  <https://winscombefurniture.com>

